



CPE The Bridge



Set-up Guide (24v OUTDOOR CPE)

Outdoor CPE/Bridge with LED display, High power industrial 5G outdoor CPE/Bridge with the next generation 802.11ac Wi-Fi standard, 802.11 ac/b/g/n 5 GHz 900 Mbps, MIMO 15dBi Dual Polarized High Gain Antenna, 500mW RF Power, Multi-Mode, Support Multi SSID up to 4, PTP/PTMP, 5KM+ Distance Coverage. 802.11ac Wi-Fi and 2*2 MIMO technology, 900Mbps wireless speed. Equipped with Gigabit Ethernet port ensures high speed internet access and more end users access.

4 in 1 Operation Mode Wireless AP, Gateway, Wireless Bridge & Super WDS, Supports HI-MAX TDMA Technology, Support Multi SSID up to 4, Support Beamforming Technology, MIMO High Gain Omni 15dBi Internal Antenna, 802.11ac, 2T2R 900M MIMO Technology, 8MB Flash, 64M DDR2 RAM,

Supports 24V Passive PoE

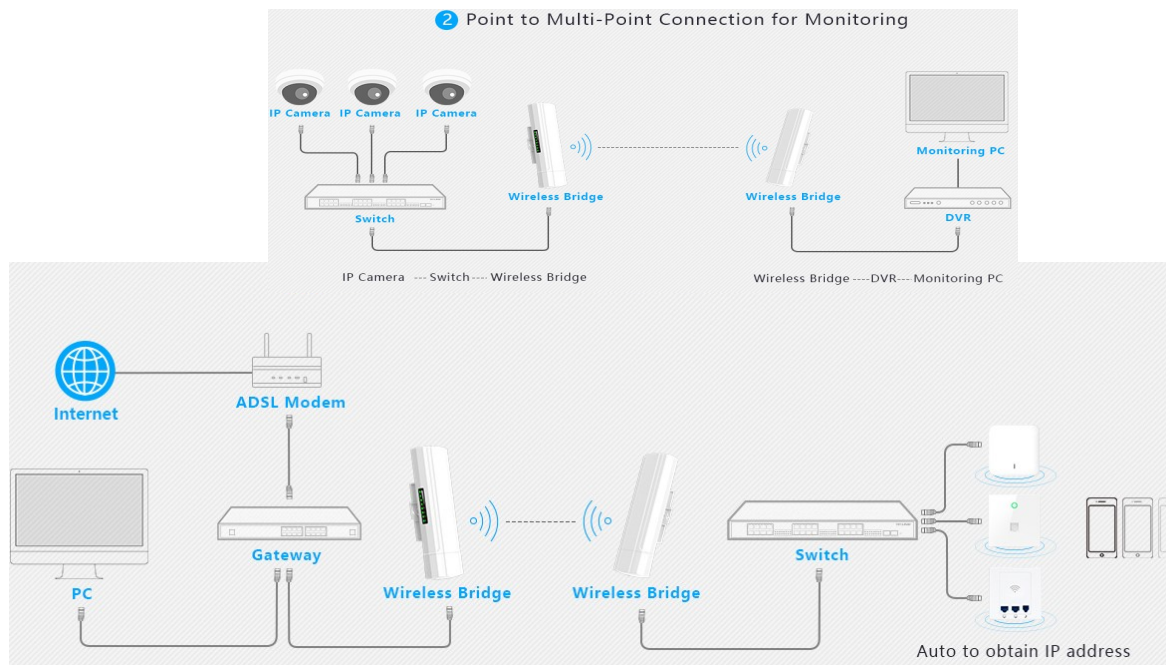

Press F Key to enter setup mode
H means Host/Master AP
C means Client/Slave AP

Press S Key & Set One unit to Host (H) and the other to Client (C) choose the same channel on both units

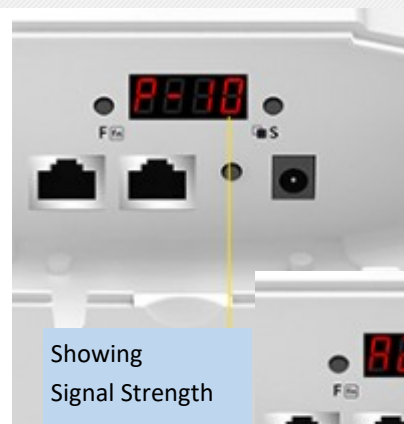

Showing Signal Strength



Showing IP Address



CPE The Bridge



Set-up Guide (24v OUTDOOR CPE)



1. Connecting to setup

If you are connecting the outdoor CPE to the PC via the cable network socket or Wi-Fi (ProWiFi 5G) password **4wG7cZXd**

You will need to change the Network settings of your PC to static.

 > Control Panel > Network and Internet > Network Connections

The settings can be found in

Set the IP of the computer to 192.168.188.250

Set the Subnet mask 255.255.255.0

Set the Default gateway to 192.168.188.253

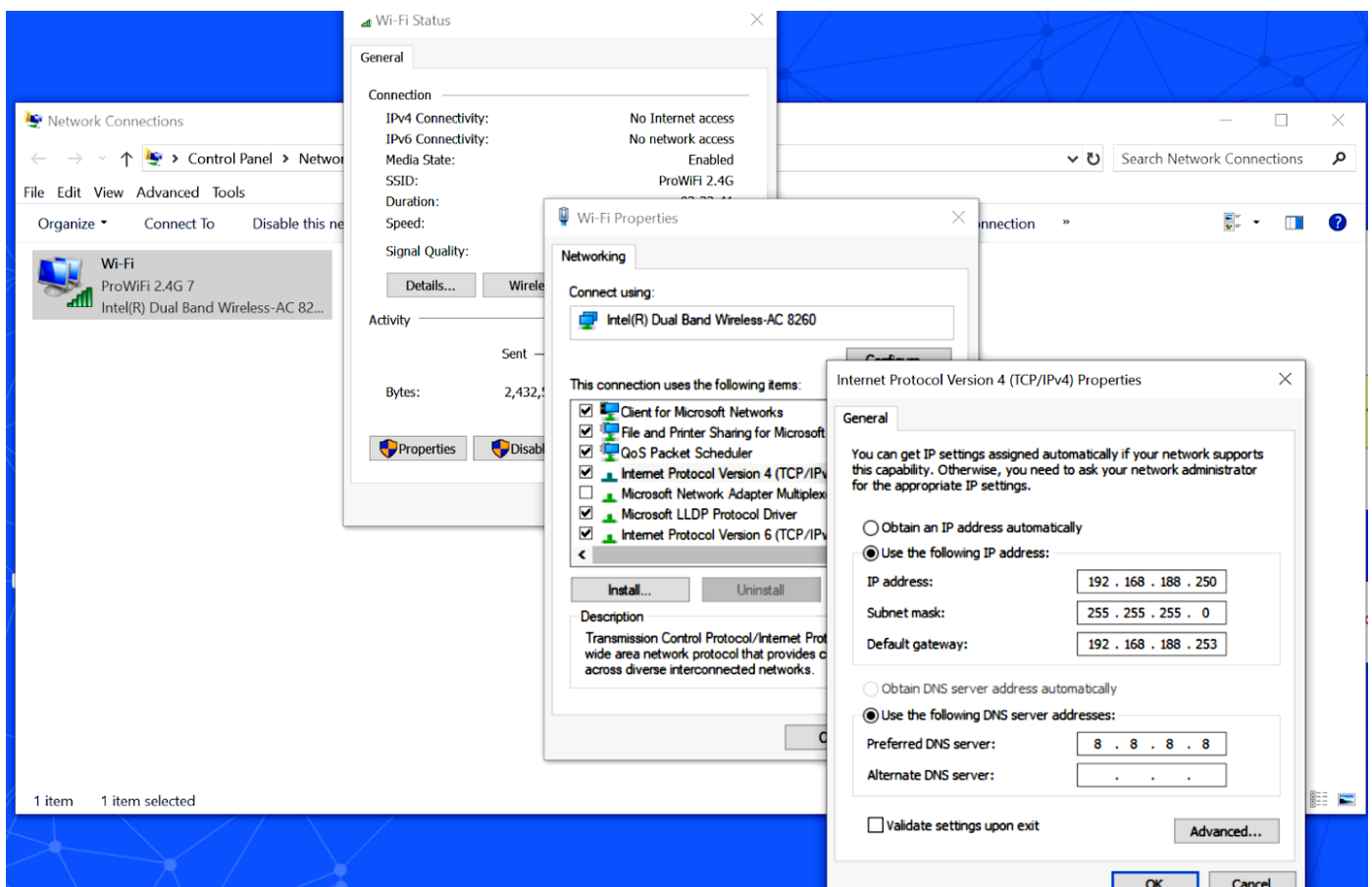

You can now access the login interface by going to 192.168.188.253 in your browser

Enter the default password **admin** on the login screen.



CPE The Bridge



Set-up Guide (24v OUTDOOR CPE)



Home

WEB GUI Configuration

Once logged in the following home page will pop up as follow:

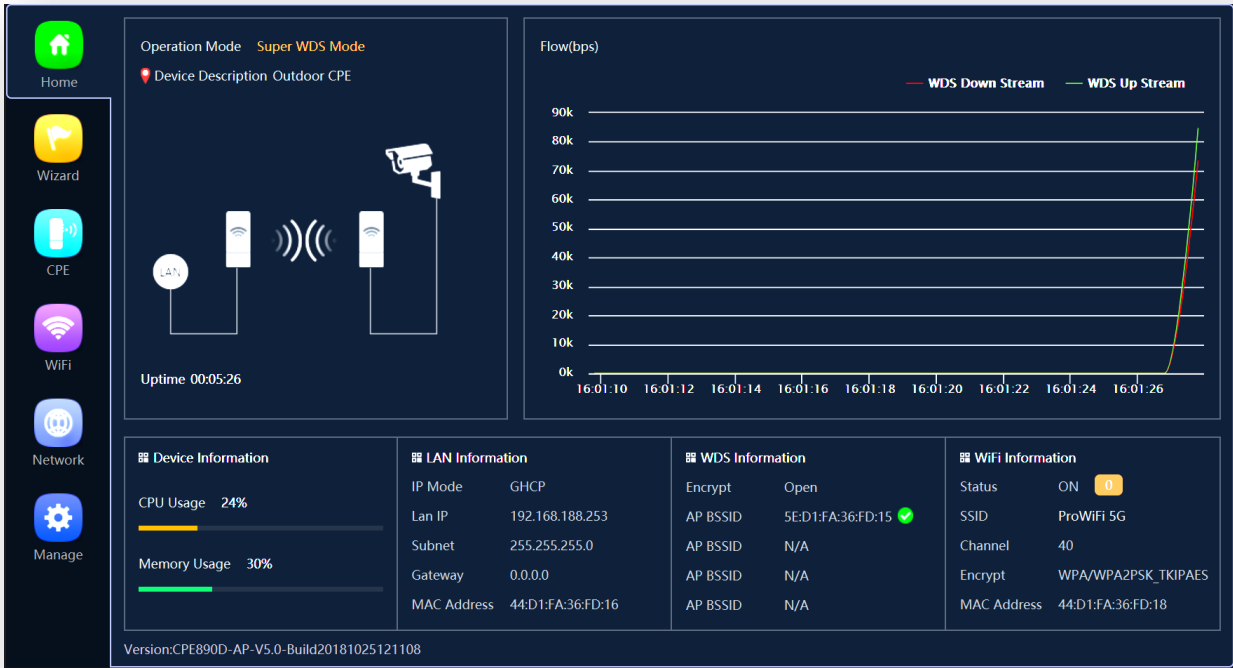

Current mode: - This shows the current operating mode (Gateway in this example)

Online users: - The number of users currently connected.

Device description:- Change this to best describe the AP or perhaps it's location)

Uptime:- The amount of time the access point as has been running since last reboot

CPU and memory usage:- A good indication of whether the AP is working too hard.



CPE The Bridge



Set-up Guide (24v OUTDOOR CPE)



Wizard



Gateway mode:-

The AP will allocate IP numbers to the connected devices. This mode is default as it permits you to connect and setup the AP very easily.

The AP could be left in this mode however, any connections to the AP (Wireless or not) will be allocated different IP addresses to the main network, potentially preventing communication between devices on the main network.

Repeater mode:-

The AP will receive & retransmit the Wi-Fi signal from another device.

It performs the same role as Access Point mode, but the key is that it talks over Wi-Fi instead. As such, this doesn't get around obstacles as well as an access point does. While an access point can be put in front of an obstacle, a repeater will need to be angled around it. However, the benefit of repeaters is that they don't need a cable to connect to the central hub.

WISP mode:-

Wirelessly connects to a WISP (Wireless Internet Service Provider) AP. In this mode, the AP also acts as a router for wired clients on your LAN and provides NAT (Network Address Translation) and a DHCP server to generate IP addresses for wired clients only. NAT and the DHCP server allow many computers to share the same wireless Internet connection.

AP mode:-

Using Access Point mode is ideal if you want to extend the Wi-Fi range and CPE you're using to extend it isn't far away from the main central router. The cable will ensure you get the best possible speeds between the access point and the router and the Wi-Fi will be transmitted in the direction of the antenna face.

Super WDS mode:- Standard (Default mode of operation for automated binding)



CPE The Bridge



Set-up Guide (24v OUTDOOR CPE)



CPE

The screenshot shows the CPE Manager interface with a sidebar on the left containing icons for Home, Wizard, CPE, WiFi, Network, and Manage. The main content area is titled 'CPE Manage' and shows 'Channel:40'. Below this is a table with the following data:

Device List	Description	MAC Address	IP Address	Signal	Status	Uptime
DEV1	Outdoor CPE	5E:D1:FA:36:FD:15	192.168.188.122	0 dBm	Online	00:12:36
DEV2	Outdoor CPE	5E:D1:FA:36:FD:15	192.168.188.122	-95 dBm	Online	00:12:36
DEV3	Outdoor CPE	5E:D1:FA:36:FD:18	192.168.188.253	-39 dBm	Online	00:06:31

CPE Manager:-

Show current state of a Wi-Fi points and signal level reception in each case. Also shows the uptime, useful for fault diagnosis and the channel in use.

MAC and IP address is also displayed, useful for AP identification.

Status will show either **Online** or **Offline** as needed.



CPE The Bridge



Set-up Guide (24v OUTDOOR CPE)



WiFi

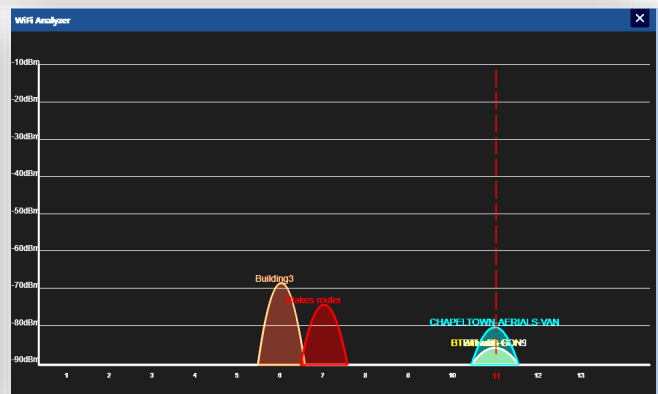
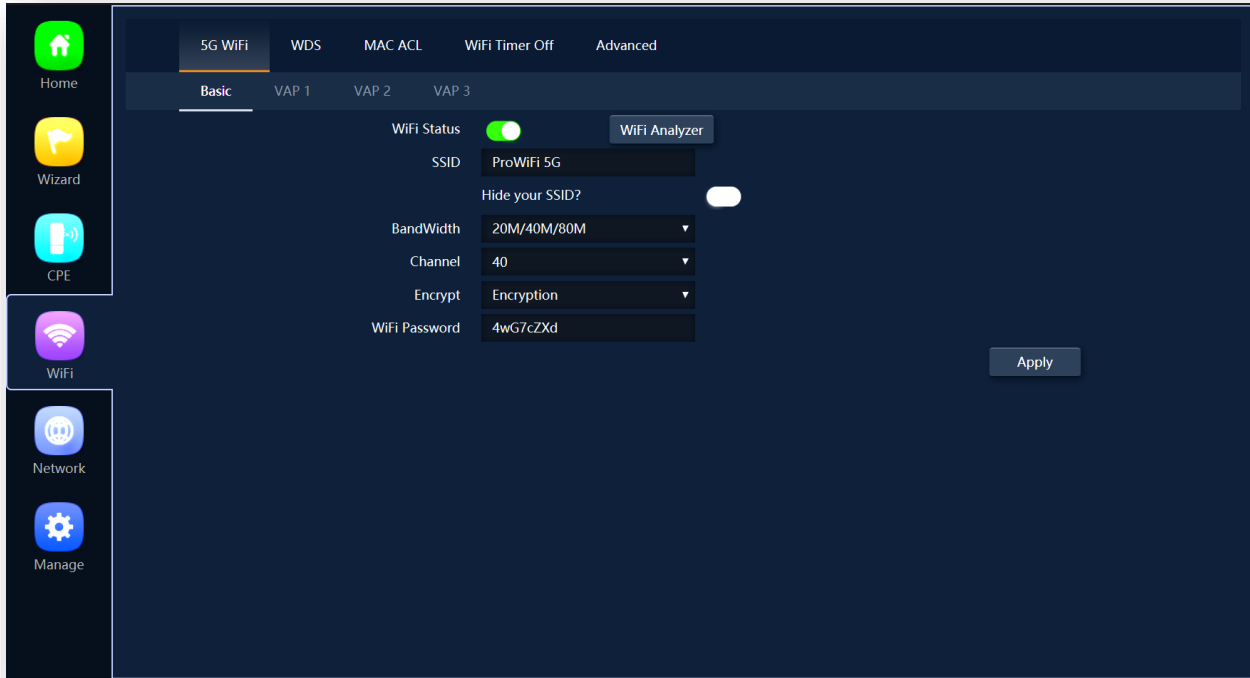

2G and 5G WiFi:- Setup the SSID (Name of the WiFi), Bandwidth, channel, Encryption and password. This area also has a built-in WiFi analyser to look for the best channel to set the 2.4/5G signal so that it doesn't clash with other channels.

MAC ACL:- Access control lists (ACL) can control the traffic entering a network. When you configure ACL, you can selectively admit or reject inbound traffic, thereby controlling access to your network or to specific resources on your network or to specific resources on your network.

WiFi Timer Off:- Set the time to start and stop WiFi access



CPE The Bridge



Set-up Guide (24v OUTDOOR CPE)



WiFi

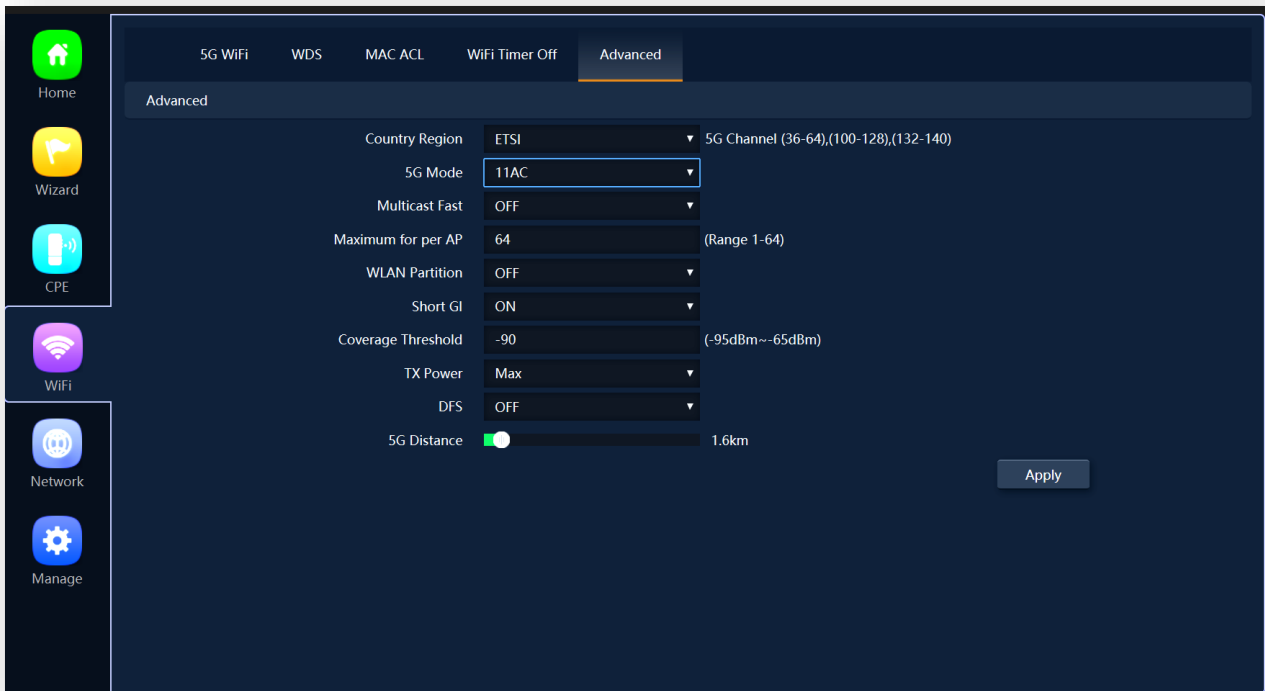

Country Region MUST be set to ETSI (For the UK channel allocation)

Multicast Fast: - Provides the ability to minimize packet loss in a network when there is a link or node failure by enhancing, but not changing, multicast routing protocols.

Maximum per AP: - Number of permitted on the AP. Prevents over loading and therefore slowing down of the AP

WLAN Partition: - For security. Enabling WLAN Partition prevents associated wireless clients from communicating with each other.

Short GI: - Short Guard Interval can increase the data rate by up to 10%.

Coverage threshold: - The signal level at the point where the AP drops the device.

TX power: - Careful setting of this can reduce the channel overlap and degrading of the Wi-Fi signal if using with more than one AP.

DFS: - When support for DFS is enabled, it will be necessary for WiFi access points to verify that any radar in proximity is not using DFS frequencies. This process is called *Channel Availability Check*, and it's executed during the boot process of the access point (AP) as well as during its normal operations.



CPE The Bridge



Set-up Guide (24v OUTDOOR CPE)



Network

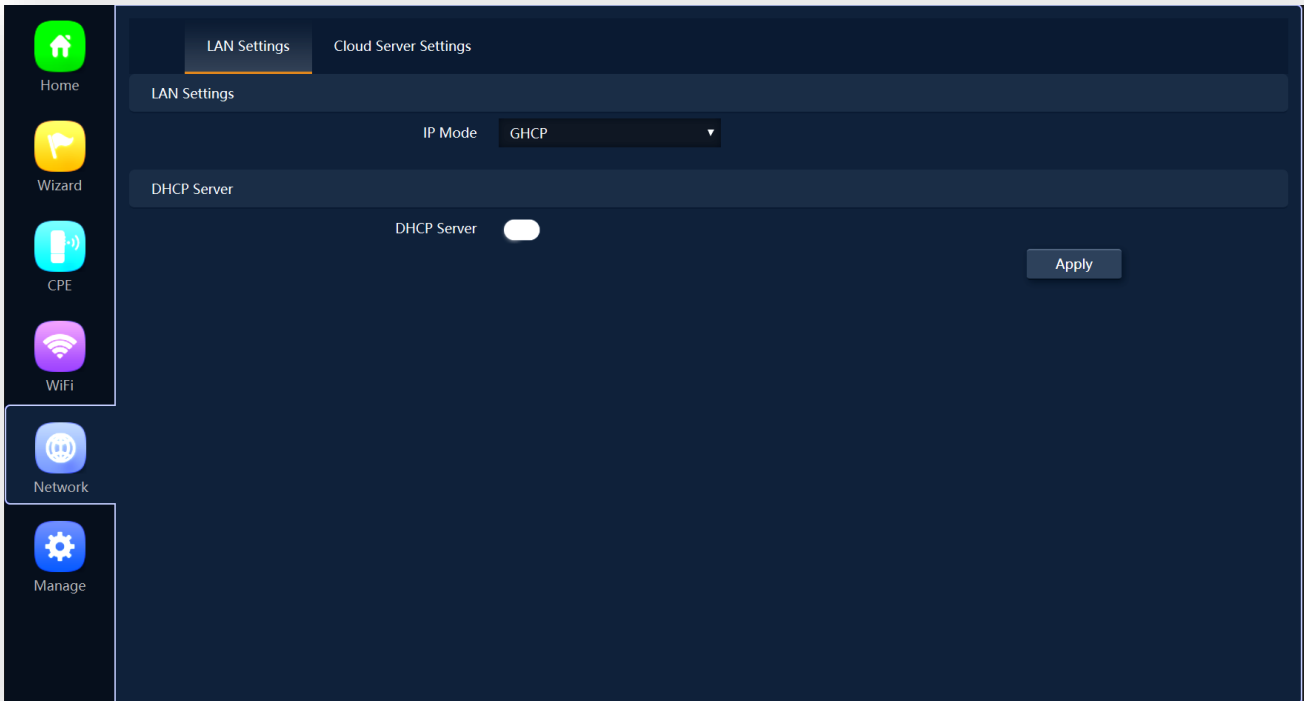

Lan IP Mode:- GHCP is the default mode of IP allocation for binding and IP allocation all are passed through in this mode. Cloud server settings are for remote access to all ProWiFi devices using a Cloud service which is free for all ProWiFi products



CPE The Bridge



Set-up Guide (24v OUTDOOR CPE)



Manage

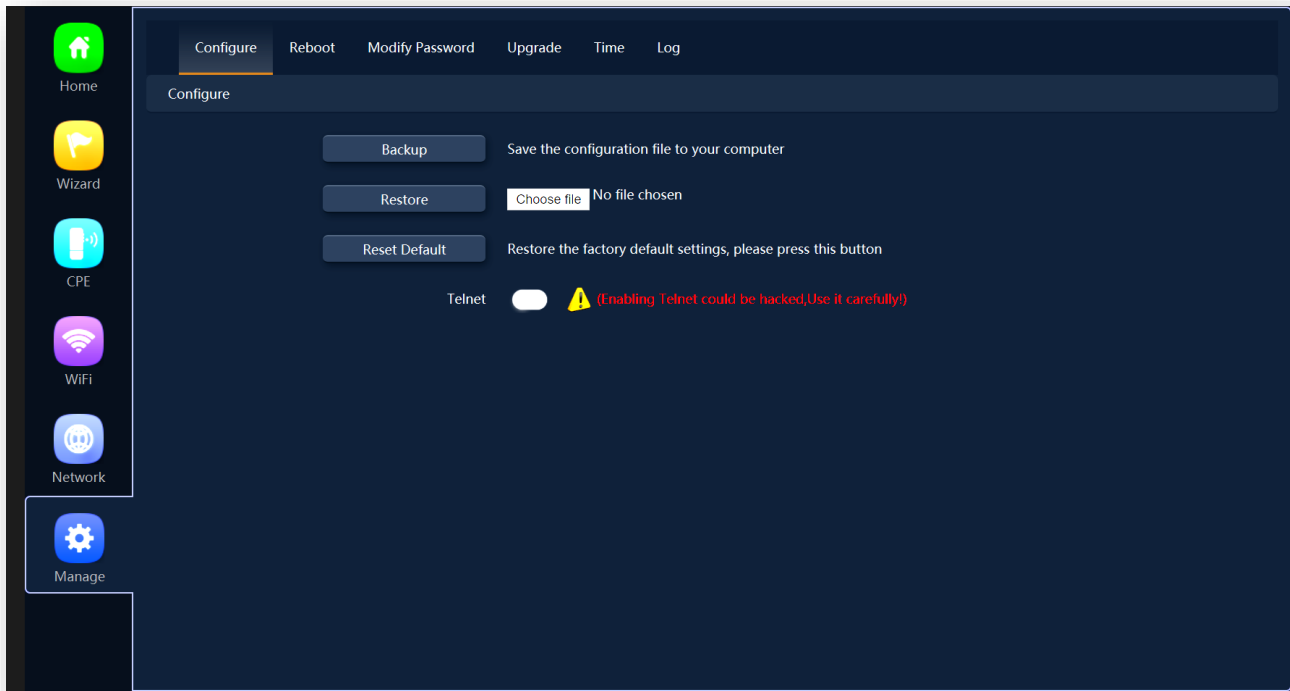

Backup:- Allows you to save the configuration file to your computer.

Restore:- Restore the back of the configuration file (also useful for installing many access points with the same configuration).

Reset Default:- Resets the access point back to the manufacturers default settings.

Telnet:- Allows access to the devices Telnet port (port 22)

As a security risk we suggest this is turned off unless specifically needed

TIPS

Due to the Browser Cache process on PC please be aware that we advise to refresh any screen before working on settings.

Usually a "force refresh" is enough.

Chrome: Press the following key combination: Shift + Ctrl + F5

IE: Press the following key combination: Ctrl + F5

Safari On PC: Ctrl + F5 or on Apple MAC: CMD + R

Alternatively, use the Chrome browser in Incognito mode can also reduce browser Cache issues.

Please see <https://www.refreshyourcache.com> for further details on the Cache process.

Access point can take up to 2 minutes to reinitialize on reboot.

Using the In-Wall AP in "AP Mode" will require you to set your devices IP to static. Set 192.168.188.250 as the device IP and 192.168.188.253 as the gateway IP address.

Easiest install is using Gateway mode (as above)

App for finding spare Wi-Fi channels is [Wi-Fi Analyzer](#) (Apple or Android)

App for searching on networks for IP is [FING](#) (Apple or Android)

Reset back to default by holding front button for 15 seconds.



CPE The Bridge



Set-up Guide (24v OUTDOOR CPE)

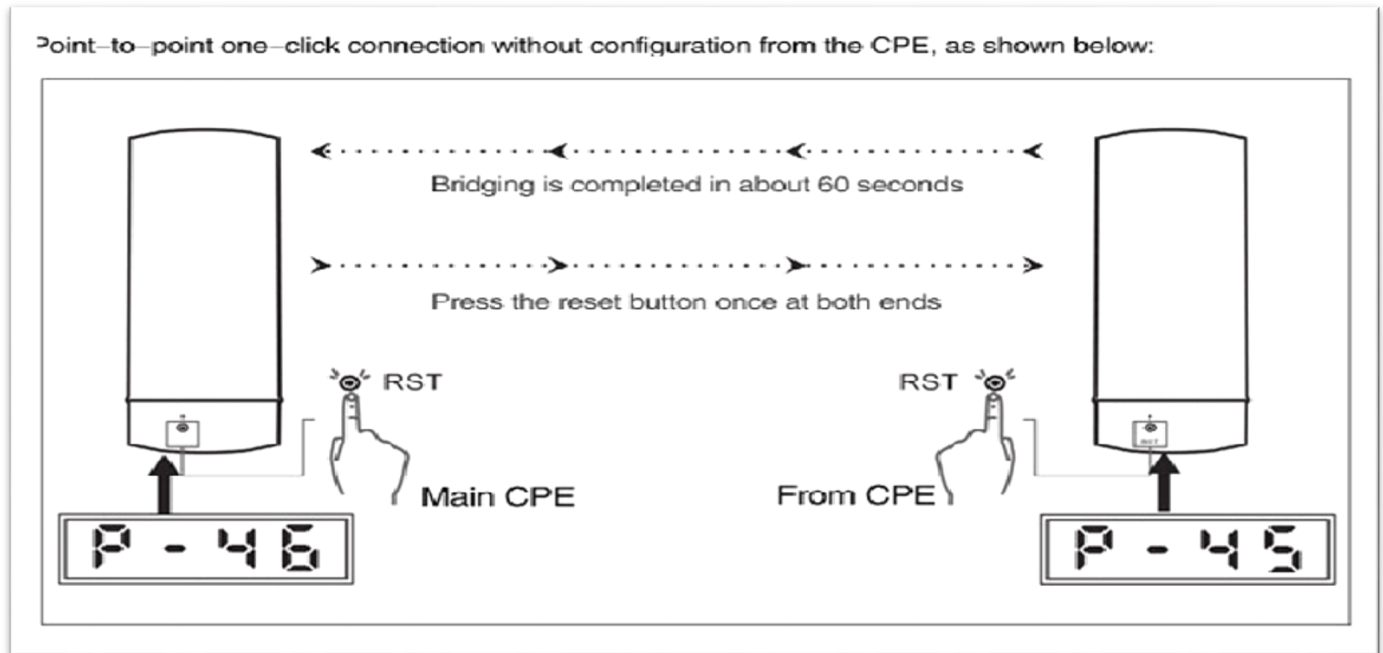

24v “The Bridge” 900Mbps 11ac 5G High Power Outdoor CPE.

1. The CPE are supplied with Jubilee clip for pole mounting but can be wall mounted with the two screw mounting holes.
2. Power the CPE with a 24v 1A POE Power supply. (PROAPPSU11)
3. Roughly align the CPE and power up.
4. Press the F button and select C (Client) on one CPE display and H (Host) on the other. The display will flash to show confirmation on saved information. Ensure that they are on the same ETSI channel.
5. Press S button to show the last 3 digits of the IP (eg A253 would be 192.168.188.253)
6. Press RST button and leave for 1 minute until the slave and host have bonded.
7. Press the select button until P is displayed.
Align both Host and Slave until the maximum achieved number is displayed.
Transmission angle is 60° maximum.

▶ PTM Point Bridge

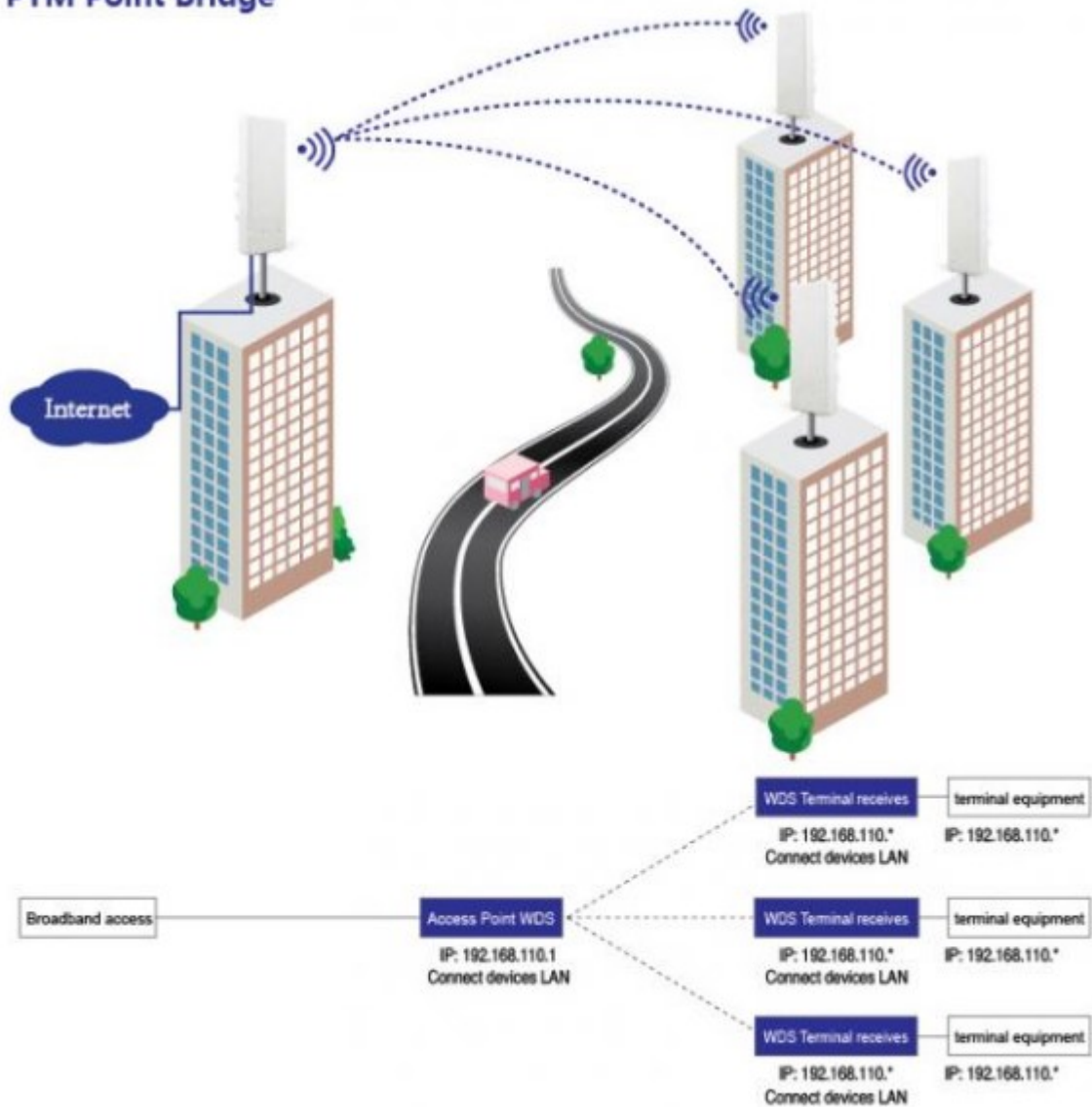

▶ Bridging distances

When two points have a long distances, point to point can't transfer, you need to add two or more devices bridging the wireless network signal to extend farther distances.

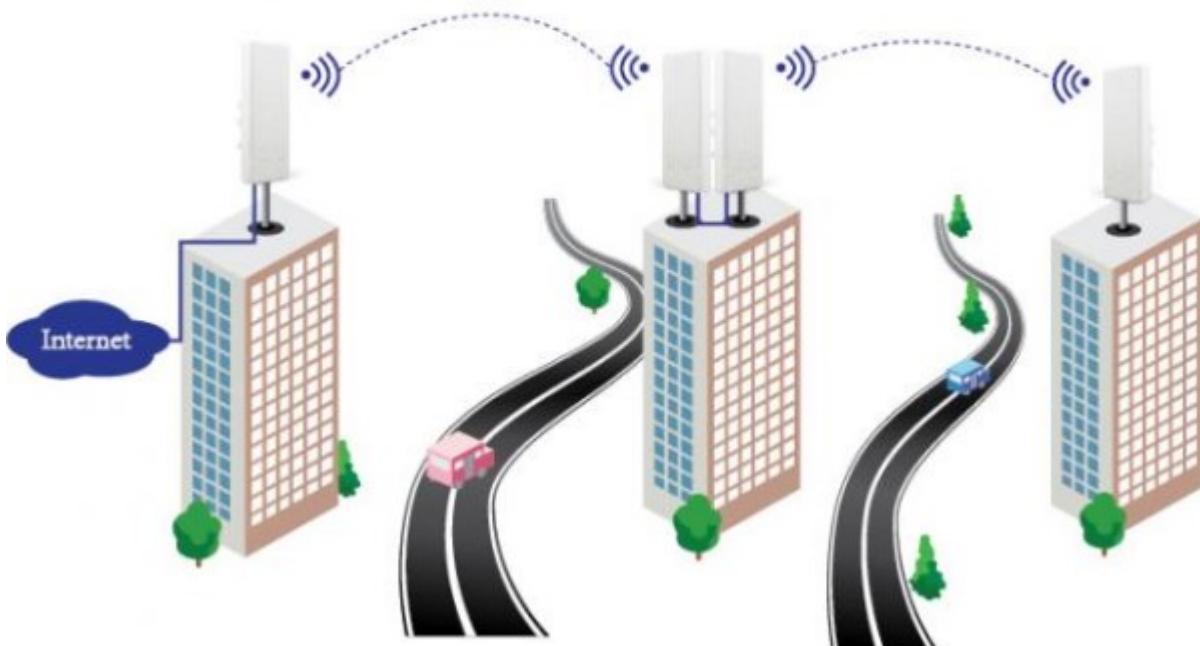

▶ PTP Bridge

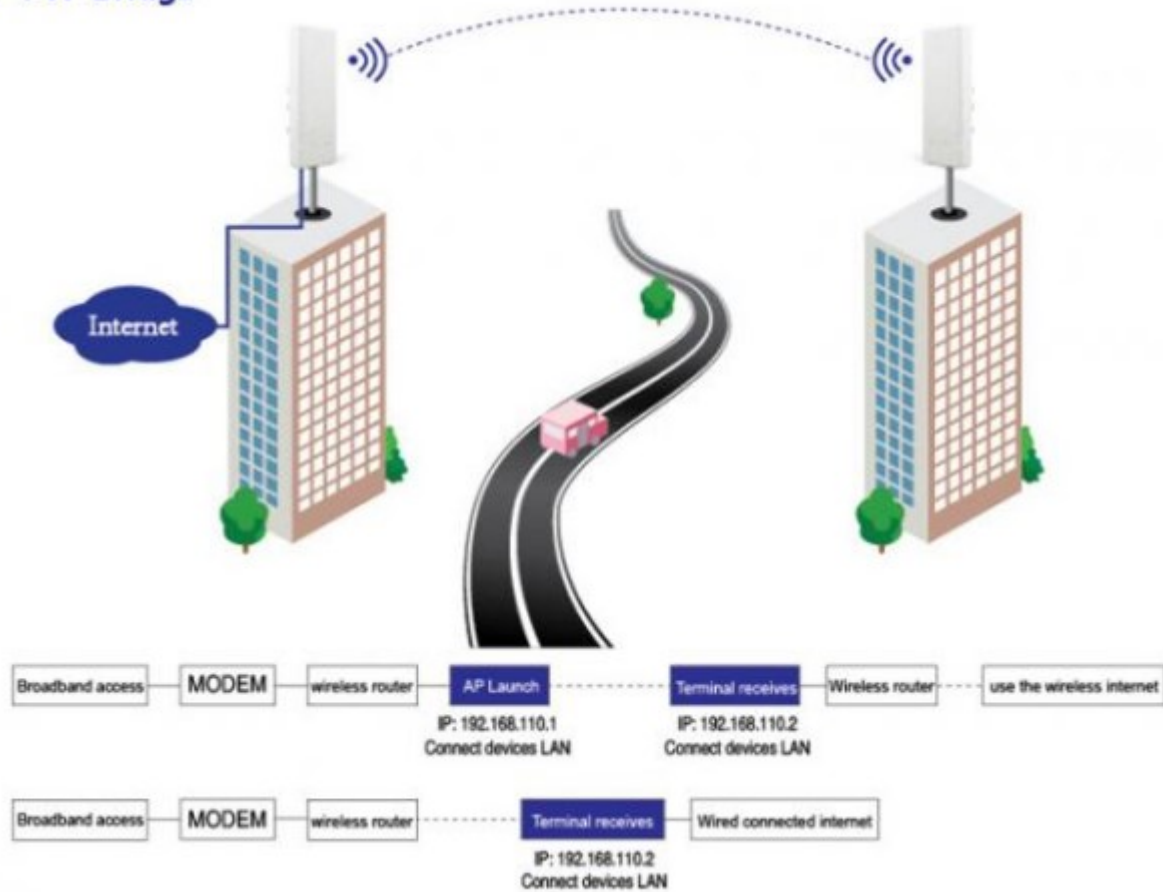

900Mbps 5G Outdoor CPE work with IP Camera

200Mbps Throughput in 1KM distance

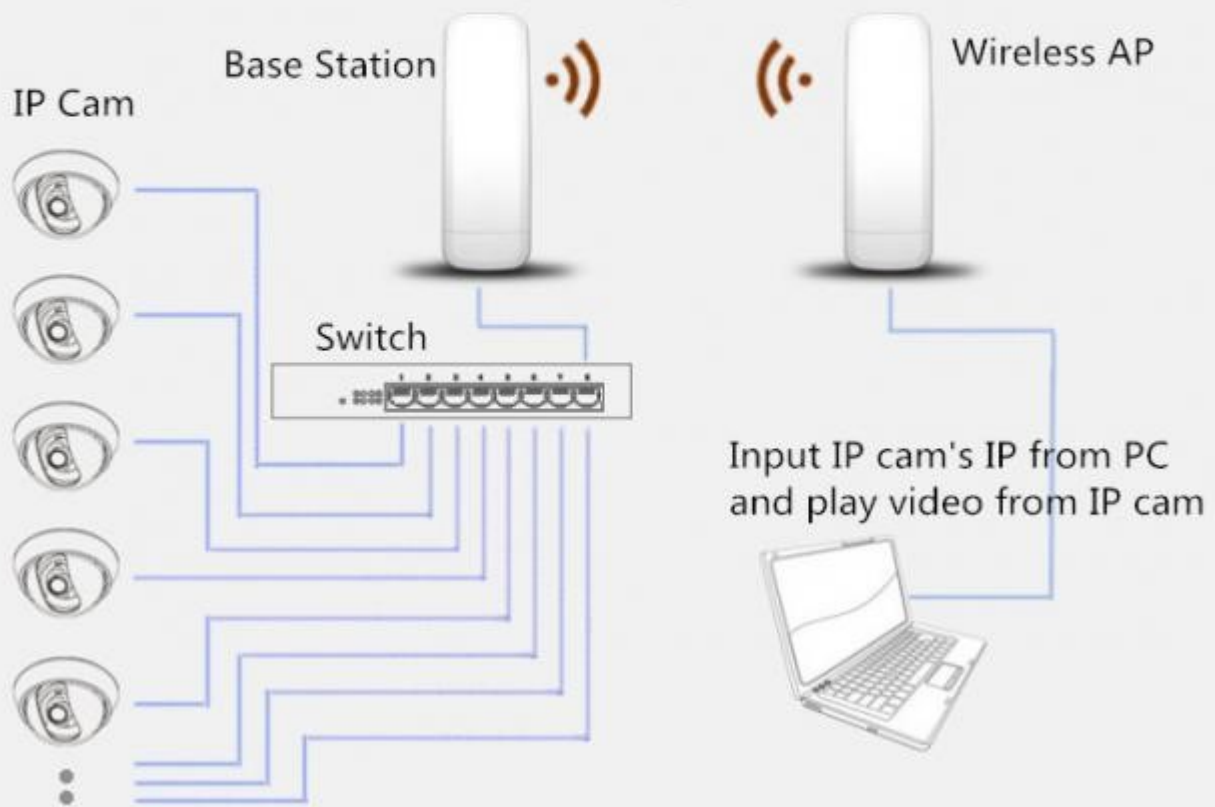



CPE The Bridge



Set-up Guide (24v OUTDOOR CPE)

Quick Set-up Guide (OUTDOOR CPE)

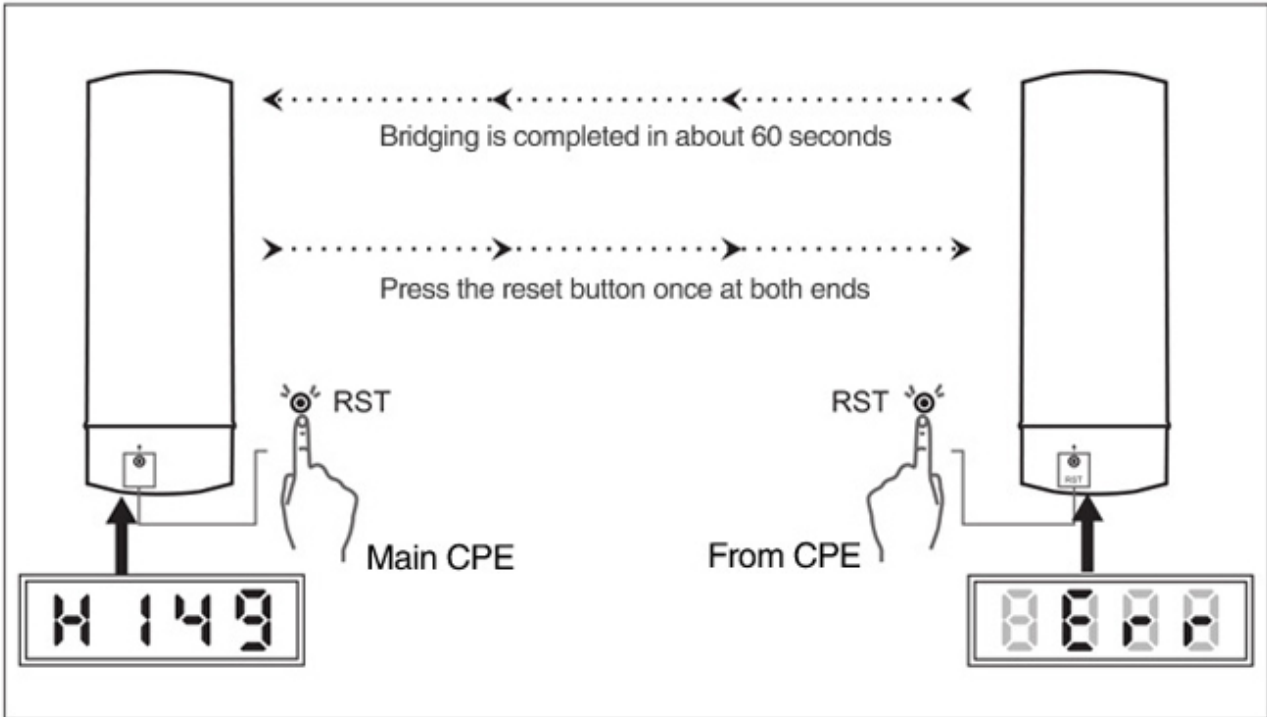

Bridging failed

Press the reset key on the Host (H) CPE and the slave (C) CPE.
 Wait upto 1 min until the rotating LED display has finished and the "P" for power (Signal Level) is displayed.

You can cycle through the display by pressing the "S" button.

Display letters are:

H or C for Host or Client, A for last 3 digits of IP number and
 P for power of received signal.

TIPS

System performance is better when distances is as close as possible

Reliability is increased when there is a clear line of sight.

The number of APs, location, size, and obstacles determine speed & reliability.

Performance & reliability of antennas are positioned higher. Antenna height is the distance from the imaginary line connecting the antennas at the two sites to ground level. Ground level in an open area is the actual ground. In dense urban areas, ground level is the average height of the buildings between the antenna sites.

Rooftop Installation Rooftop installations offer several advantages: ?? Fewer obstacles in the path. ?? Improved performance due to greater height. Rooftop Installation

Rooftop installations offer several advantages:

Fewer obstacles in the path and Improved performance due to greater height.

Antenna polarization must be the same at both ends of the link



CPE The Bridge



Set-up Guide (24v OUTDOOR CPE)

Hardware:					
Chipset	RTL8197FH +RTL8211F+RTL8812BRH				
Standard	802.11ac/a/n, MIMO technology				
Memory	128MB DDR2 RAM				
Flash	8MB				
Interface	1 * 10/100 /1000Mbps RJ45 WAN Port				
	1 * 10/100Mbps RJ45 LAN Port				
	1 * LED display				
	1 * F(Function) switch button				
	1 * S(Select) button, press it to setup WDS PTP/PTMP connection				
	1 * DC Jack				
	1 * Reset button, press 15 seconds to revert to default setting, press 1 seconds to do the WDS connection				
Antenna	Build in 15dBi MIMO Panel Antenna				
Power consumption	24V PoE<13W				
Size	260mm*85mm*45mm				
RF Data					
	5GHz:802.11a/n/ac				
Frequency	5GHz :5.150GHz~5.850GHz				
Modulation	OFDM = BPSK,QPSK, 16-QAM, 64-QAM				
	DSSS = DBPSK, DQPSK, CCK				
Throughput	900Mbps				
RF Power	802.11a	54M	23±2dBm	6M	26±2dBm
	802.11n HT20	MCS7	22±2dBm	MCS0	25±2dBm
	802.11n HT40	MCS7	21±2dBm	MCS0	24±2dBm
	802.11ac HT80	MCS9	20±2dBm	MCS0	23±2dBm
Receive Sensitivity	802.11a	54M	-72dBm	6M	-90dBm
	802.11n HT20	MCS7	-70dBm	MCS0 .	-88dBm
	802.11n HT40	MCS7	-68dBm	MCS0 .	-86dBm
	802.11ac HT80	MCS9	-58dBm	MCS0 .	-85dBm
EVM	802.11a: ≤-25 dB 802.11n: ≤-28 dB 802.11ac: ≤-32 dB				
PPM	±20ppm				
Max Users	64+				
Firmware Features:					
Operation mode	Wireless AP, Gateway, Wi-Fi Repeater, Super WDS				
WAN Type	Dynamic IP/Static IP/PPPoE/L2TP(Dual Access) /PPTP(Dual Access)				
Wireless Security	64/128-bit WEP, WPA / WPA2, WPA-PSK/ WPA2-PSK encryption				
SSID	Multiple SSID up to 4				
Firewall	DoS, SPI Firewall, IP Address Filter/MAC Address Filter/Domain Filter IP and MAC Address Binding				
Protocols	IPv4				
Others:					
Package Contents	900Mbps Dual Band wireless access point Ethernet Cable Quick Installation Guide Setting Accessory				
System Requirements	Microsoft Windows 98SE, NT, 2000, XP, Vista™ or Windows 7, Windows 8, MAC OS, NetWare, UNIX or Linux				
Environment	Operating Temperature:-30~55 □ Storage Temperature: -40~70 □ Humidity: 5%~95% non-condensing				
Management	Firmware GUI ,Remote Management, WLAN Controller, Cloud Management System				