

All-RackTM



WALL MOUNTED CABINET

6U - 565x450

WALL TYPE

All-Rack™

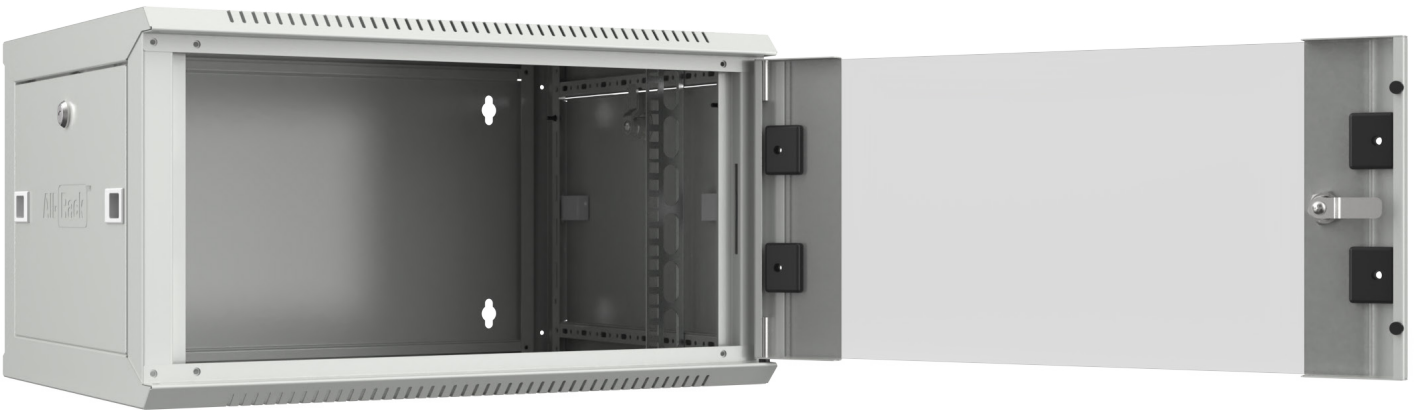

WALL MOUNTED CABINET
RAL9005 & RAL7035

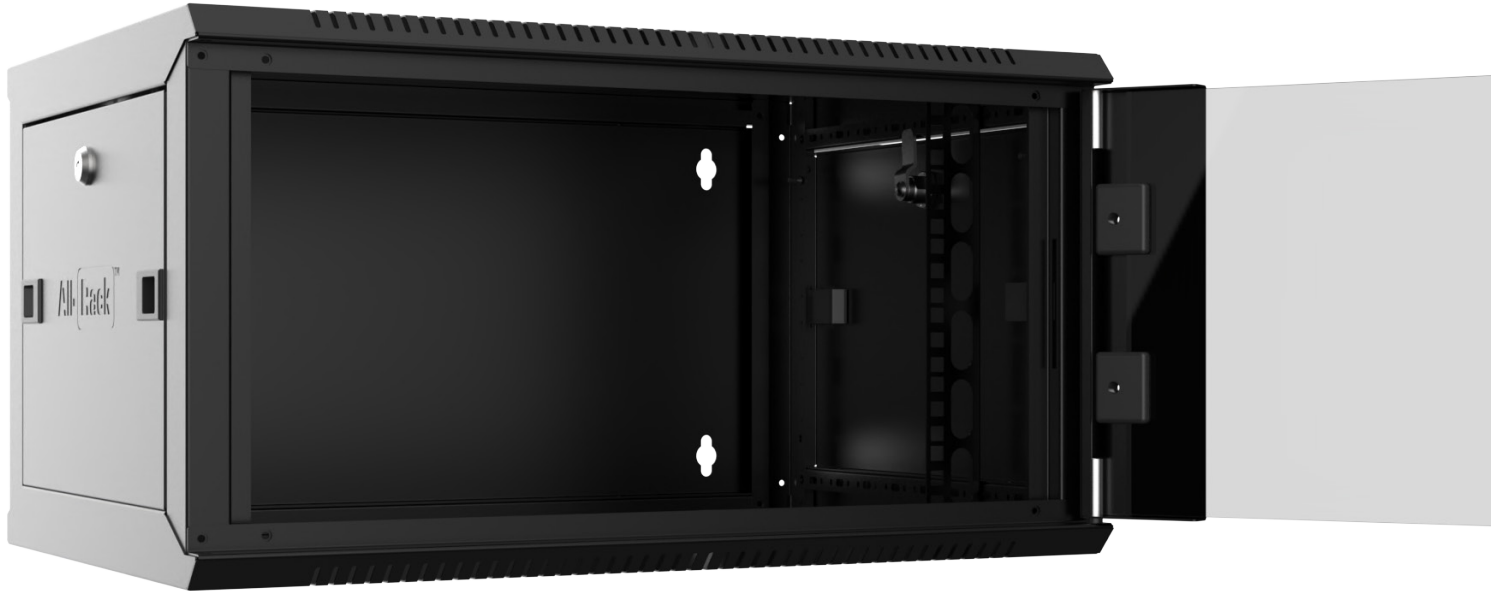

Technical Details

Features

- Compatible with 19" rack mountable products
- Added ventilation around the cabinet
- Top & bottom cable entry
- Rear plastic cable entry
- Toughened glass front door
- Plastic locking mechanism (latches on side panels)
- Barrel locking mechanism (front door)
- Earthing terminals
- Integral cable management in mounting profiles
- Numbered and adjustable mounting profiles
- Grommets on base thus avoiding direct contact with an abrasive surface if cabinet is not wall mounted

Dimensions

Size : 6U
Width : 565 mm
Height : 310 mm
Depth : 450 mm
Net Weight : 12.5kg
Gross Weight : 13kg

Loading Capacity

40 kg

Material

Steel Construction

- Main body 1 mm
- Side panels 1.2 mm
- Front door: 1.2mm
- Vertical rails 1.5 mm
- Finish Surface : Powder Coating
- Color Code : RAL7035

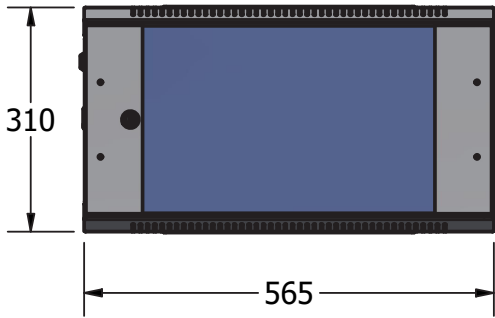

Front View

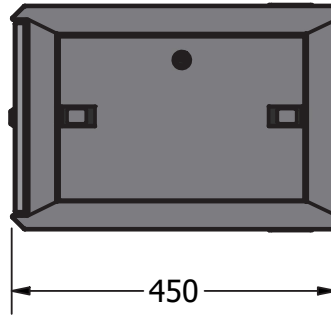

Side View

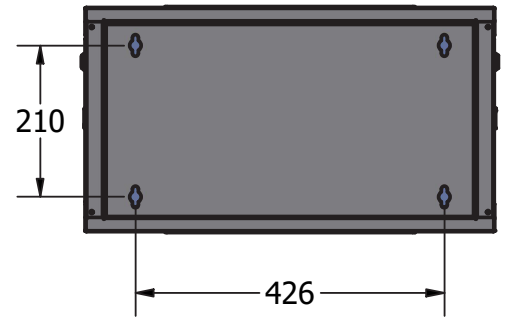

Rear View

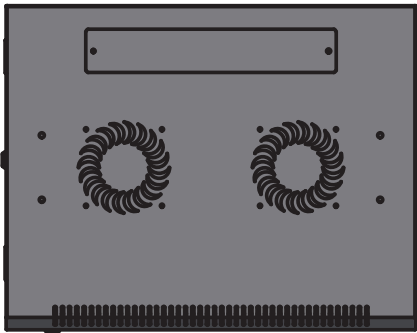

Top View

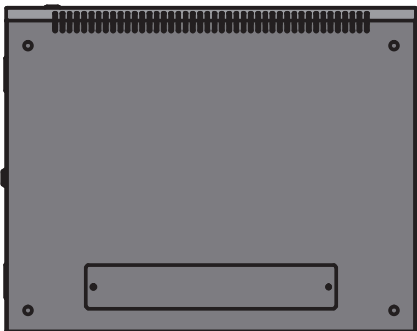

Bottom View

STANDARDS AND COMPLIANCES

ISO9001:2015 Quality Management System

IEC 297-1, 19" Mounting Standard

IEC 297-2, Overall Cabinet Dimensions

TS EN 61587-1 Standard.

Environment Friendly

%100 recyclable.



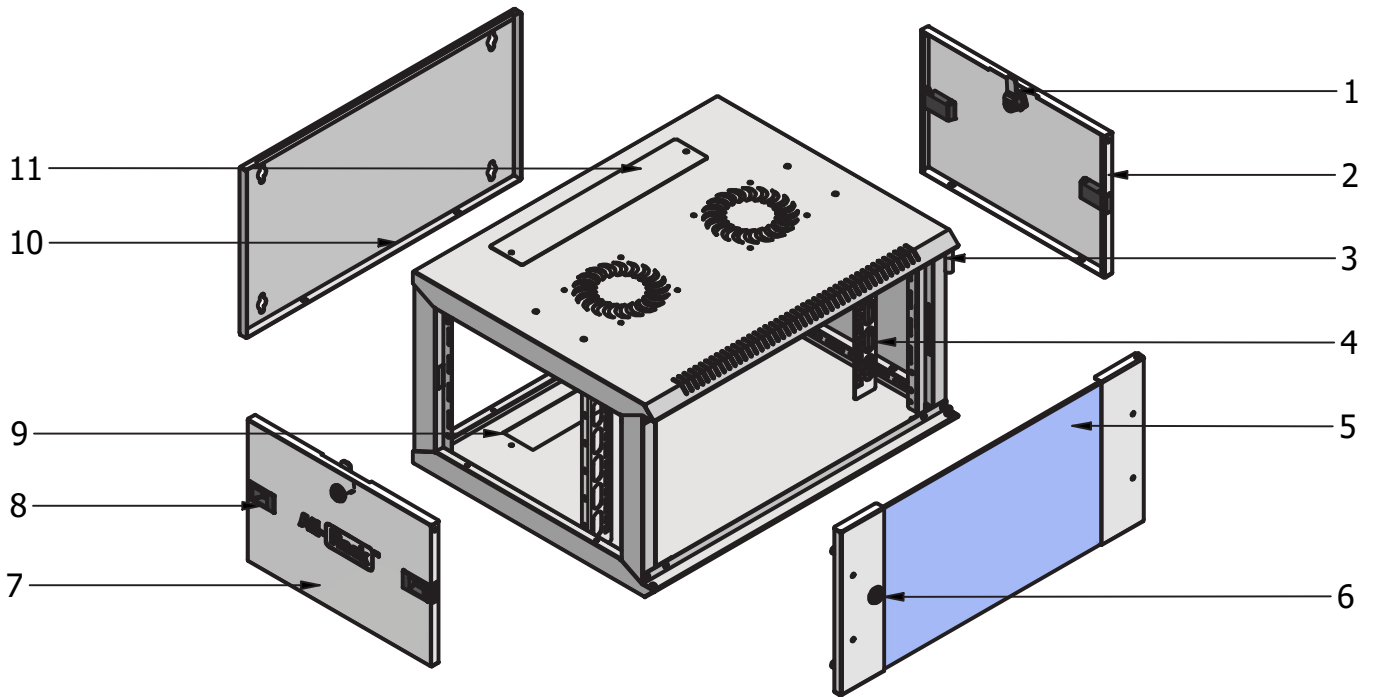

COMPONENT LIST

NO	PART NAME	NO	PART NAME
1	Side Panel Barrel Lock System	7	Side Panel with embossed All-Rack logo
2	Side Panel	8	Side Panel Slide Lock Latching System
3	Cabinet Body	9	Bottom Panel Cable Entry
4	19" Device Mounting Rail with integral cable management	10	Rear Panel
5	Toughened Glass Front Door	11	Top Panel Cable Entry
6	Front Door Barrel Lock System		



Side Panel Lock System

Removable and lockable side panel simplifies and secures your installation, comprising of Barrel Lock and sliding spring latch mechanism.



Plastic Cable Entry

The standard configuration of the CAB6WB450BLK has a plastic knock-out cable entry on the rear



19" Device Mounting Rail

Internal numbered uprights with additional built in cable management. Using standard M6 cage nuts.

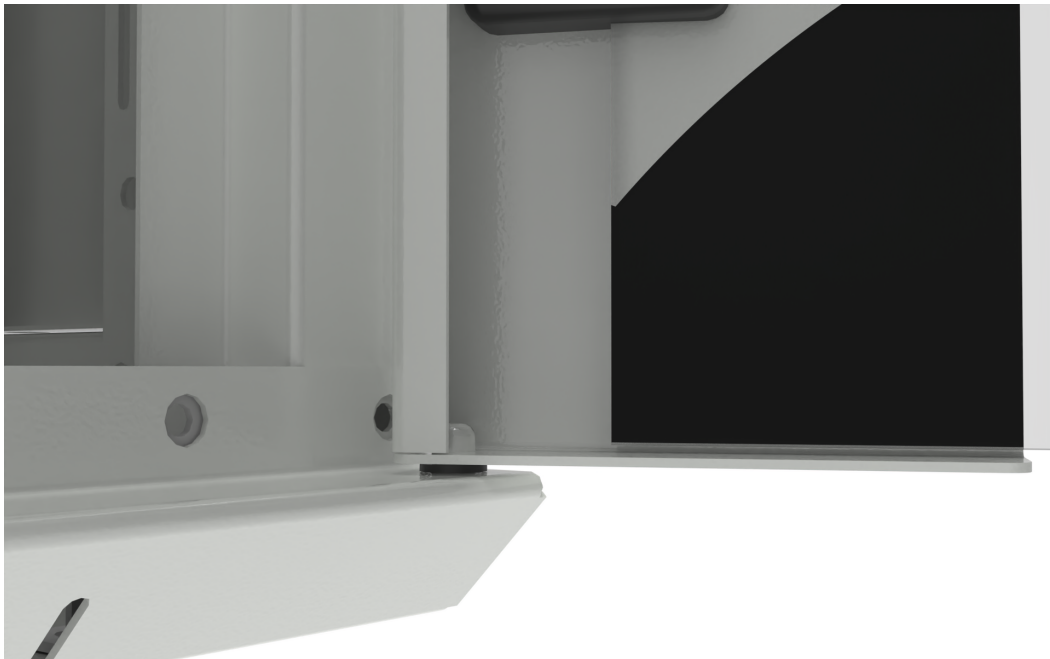

Front door can be mounted on the left or right hand side using our simple spring latch fixing posts at the top. Durable Fixed grommet rings are used to keep the door on a smooth hinge on the bottom.