

5G FILTERED AERIALS

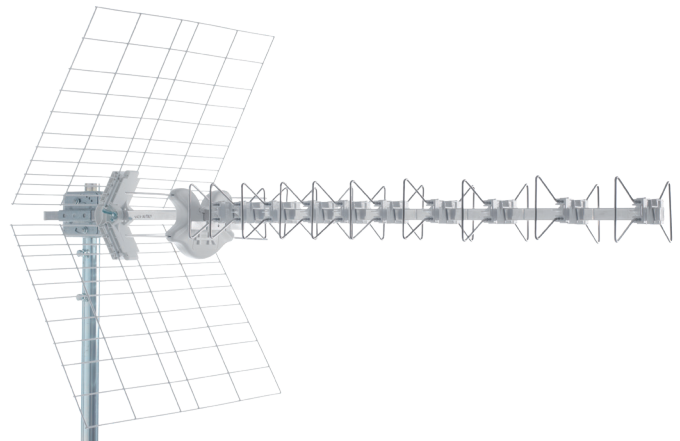
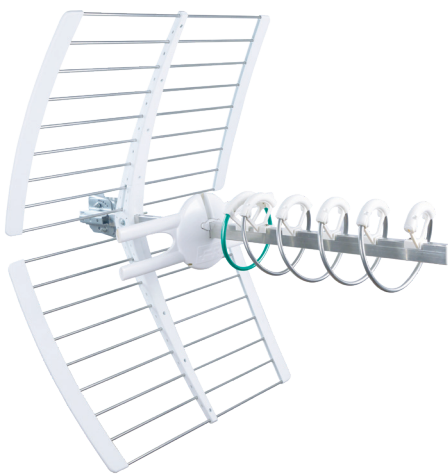

ELIKA PRO 700 C

The Elika PRO 700 C is Fracarro's unique active helical UHF band aerial used to receive digital terrestrial signals complete with LED monitoring system.

It can be assembled and fitted without tools, has pre-mounted director elements, quick-fit balun and reflectors and mast bracket with elevation adjustment.

The **automatic gain control (AGC)**, signal monitoring LED, shielding and **new 5G LTE filter inserted in the dipole** make the ELIKA PRO 700 C aerial the ultimate evolution of Loop Yagi technology. **It is patented by Fracarro and compliant to 2014/53/UE** (RED – Radio Equipment Directive). This aerial stands out for its high gain (47.5dBi), extraordinary directivity and almost **total absence of the lateral lobes** making this aerial ideal for receiving DVB-T2 signals.

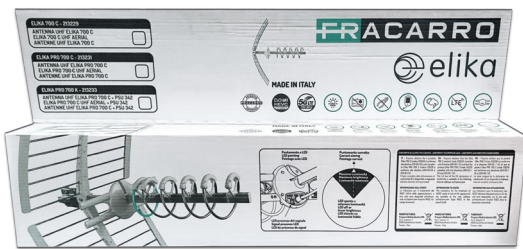

The new **single cardboard packaging** guarantees greater protection during transport and makes it easier to store.

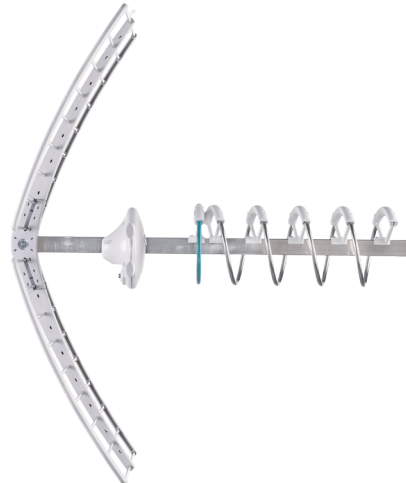
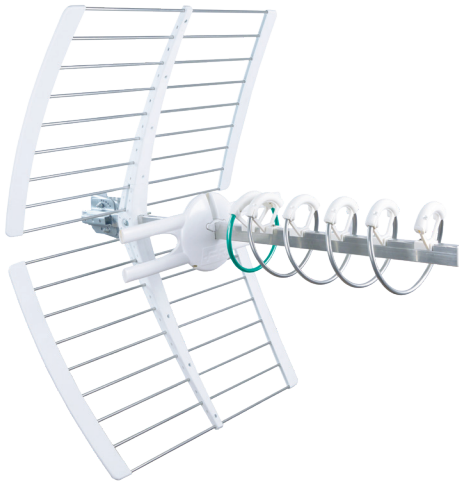

5G
integrated filter



LED
monitoring
system



Maximum signal
protection



Easy mounting
no tools required



Robust aerial



ELIKA PRO vs ELIKA

Elika PRO: Automatic gain control (AGC) and extraordinary directivity

Elika: High gain (17.5dBi) and extraordinary directivity

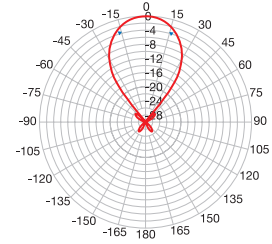
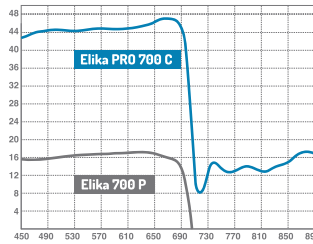

LED ALIGNMENT SYSTEM

Elika PRO is the only aerial with **LED assisted alignment**, patented by Fracarro.

213233 - **Elika PRO 700 K** kit version available with PSU342

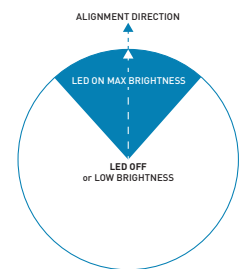
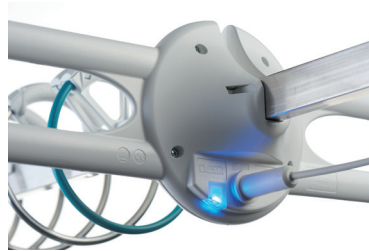

ELIKA 700 C

The Elika 700 C is a **helical UHF band aerial** with a **5G LTE filter inserted in the dipole** which stands out due to its **high gain** (17.5dBi) and **extraordinary directivity**. It is ideal for managing DVB-T2 signals which require extra protection from interference and provides good signal quality into the distribution network or outlets.

No tools are required for assembly and mounting of the aerial. The ELIKA 700 C is **packaged singly in cardboard** guaranteeing greater protection during transport and making it easier to store. Also available with single plastic bag packaging, code 213228 - **ELIKA 700 P**

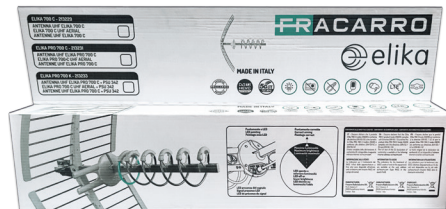
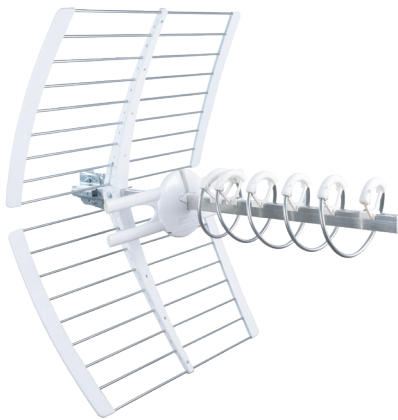

5G
integrated filter



Easy mounting
no tools required



Robust aerial

ALPHA 700 Series

Loop Yagi UHF band aerials with a **5G filter inserted in the dipole** which stands out for its **high gain**, impedance matching and directivity and manages DVB-T2 signals well.

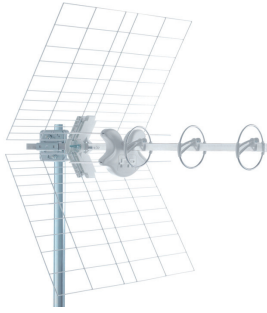

They can be **assembled and fitted without tools** and have pre-mounted director elements, quick-fit balun and reflectors and mast bracket with elevation adjustment. **Exclusive design patented by Fracarro.**

ALPHA 3 HD 700

The ALPHA 3 HD 700 aerial has **grid reflectors** and is quick and easy to install due to the quick-fit balun and reflectors. It is a 3 element aerial.



5G integrated filter



Easy mounting no tools required



Robust aerial

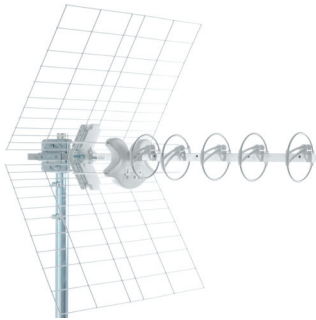

ALPHA 5 HD 700

The ALPHA 5 HD 700 aerial has **grid reflectors** and is quick and easy to install due to the quick-fit balun and reflectors. It is a 5 element aerial.



5G integrated filter



Easy mounting no tools required



Robust aerial

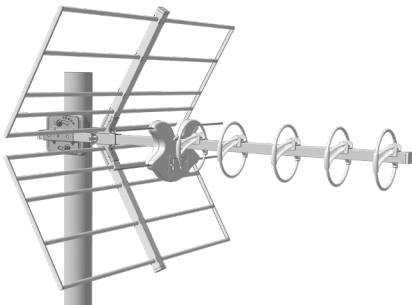

ALPHA5+ LTE700

This version has **tube reflectors** and is particularly robust due to the cradle fixing using bolts and wingnuts. It is a 5 element aerial.



5G integrated filter



Easy mounting no tools required



Robust aerial

BLU 5G Series

The BLU 5G range of UHF aerials are equipped with **grid reflectors**, F connector and a **5G LTE integrated filter**. They can be assembled and fitted without tools and have pre-mounted director elements, quick-fit balun, reflectors and mast bracket with elevation adjustment.

With **high gain, optimum impedance matching and excellent directivity** they are ideal for managing DVB-T2 signals, which

require extra protection from interference and provide good signal quality into the distribution network or outlets.

The materials used for the BLU 5G aerials have been chosen with great consideration to guarantee good **mechanical strength** and the innovative pole mounting with elevation adjustment ensures excellent wind resistance.

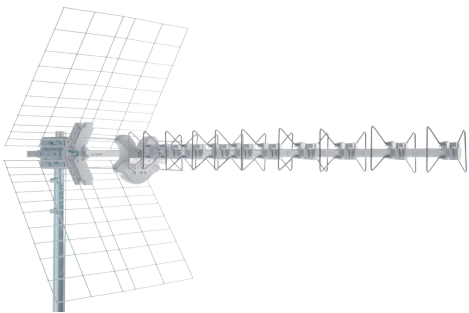

5G
integrated filter



Easy mounting
no tools required



Robust aerial

5G Log Periodic Series

These Fracarro Log Periodic 5G aerials have been **redesigned to obtain excellent 5G LTE filtering**. They are pre-assembled and easy to connect due to the F connector being located near the mast clamp. These aerials can be mounted vertically or horizontally with no additional parts required.

The meticulous design of these aerials is highlighted by the **special connection to the dipole** which provides good contact reliability with the F connector in all environments as it is protected by a weatherproof cover. The **mechanical fixing strength** of the elements to the cradle and the antenna to the pole are very robust and reliable.

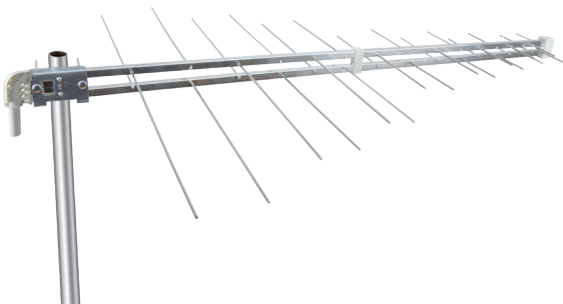

New design for
5G filtering



Easy mounting
no tools required

TAU 5G Series

The TAU 5G aerials have been **redesigned** and developed to **optimise the filtering of 5G LTE signals**.

These UHF band Yagi aerials, with F connector, can be **assembled and fitted without tools** and have pre-mounted elements, quick-

fit balun, reflectors and mast bracket with elevation adjustment.

The 8mm extruded aluminium tubes offer great mechanical strength to the TAU 5G aerials which are also **light in weight** and have rounded elements.

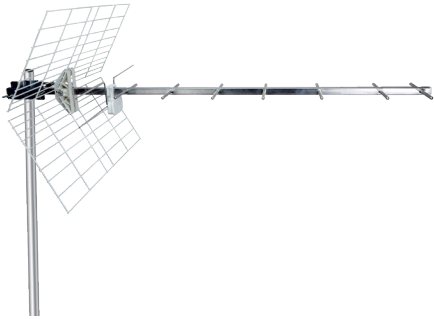

TAU11/45 5G

The TAU11/45 5G aerial has **grid reflectors** and is quick and **easy to install** due to the quick-fit balun and reflectors.



New design for
5G filtering



Easy mounting
no tools required



Robust aerial



TAU15/45 5G

This TAU15/45 5G version has **tube reflectors** and is **particularly robust** due to the cradle fixing using bolts and wingnuts.



New design for
5G filtering



Easy mounting
no tools required



Robust aerial

ELIKA SERIES

| Product | Code | Channels | Bands | Gain | Packaging |
|------------------------|--------|--|------------|-------|--|
| ELIKA 700 C | 213229 | E21-E48 | 470-694MHz | 17dBi | Single: cardboard box, multiple: 6 pcs |
| ELIKA 700 P | 213228 | E21-E48 | 470-694MHz | 17dBi | Single: plastic bag, multiple: 10 pcs |
| ELIKA PRO 700 C | 213231 | E21-E48 | 470-694MHz | 47dBi | Single: plastic bag, multiple: 6 pcs |
| ELIKA PRO 700 K | 213233 | KIT composed of: ELIKA PRO 700 C and PSU342 (24V and 100mA PSU with 2 outputs), | | | multiple: 6 pcs |

ALPHA 700 SERIES

| Product | Code | Channels | Bands | Gain | Packaging |
|-----------------------|--------|----------|-------------|---------|---|
| ALPHA 3 HD 700 | 213239 | E21-E48 | 470-694 MHz | 13dBi | Single: cardboard backing, multiple: 10 pcs |
| ALPHA 5 HD 700 | 213240 | E21-E48 | 470-694 MHz | 14dBi | Single: cardboard backing, multiple: 10 pcs |
| ALPHA5+ LTE700 | 213225 | E21-E48 | 470-694 MHz | 14.2dBi | Single: cardboard box, multiple: 12 pcs |

BLU 5G SERIES

| Product | Code | Channels | Bands | Gain | Packaging |
|-------------------|--------|----------|-------------|---------|---|
| BLU5HD 5G | 217914 | E21-E48 | 470-694 MHz | 13.5dBi | Single: cardboard backing, multiple: 10 pcs |
| BLU10HD 5G | 217915 | E21-E48 | 470-694 MHz | 15.5dBi | Single: cardboard backing, multiple: 10 pcs |
| BLU22HD 5G | 217916 | E21-E48 | 470-694 MHz | 18dBi | Single: cardboard box, multiple: 2 pcs |

5G LOG-PERIODIC SERIES

| Product | Code | Channels | Bands | Gain | Plastic colour | Packaging |
|--------------------------------------|--------|-------------------------|----------------------------|-------------------|----------------|-----------|
| LP45F700MINI | 216256 | E21-E48 | 470-694 MHz | 9dBi | Black | 30 pcs |
| LP45HV 5G | 216259 | E21-E48 | 470-694 MHz | 12dBi | White | 30 pcs |
| LP45F 5G | 216258 | E21-E48 | 470-694 MHz | 12dBi | White | 30 pcs |
| LP45F 700 | 216251 | E21-E48 | 470-694 MHz | 12.5dBi | Black | 30 pcs |
| LP45NF 5G | 216252 | E21-E48 | 470-694 MHz | 12.5dBi | White | 30 pcs |
| LP345MF 700 | 216254 | E5-E12 + DAB E21-E48 | 174-240 MHz 470-694 MHz | 8,5dBi 10dBi | Black | 20 pcs |
| LP345HV 5G clamp connector | 216253 | E5-E12 + DAB E21-E48 | 174-240 MHz 470-694 MHz | 9dBi 11dBi | White | 20 pcs |
| LPV345F 5G | 217251 | E5-E12 + DAB E21-E48 | 174-240 MHz 470-694 MHz | 9dBi 11dBi | White | 20 pcs |
| LP345F 700 | 216255 | E5-E12 + DAB E21-E48 | 174-240 MHz 470-694 MHz | 9,5dBi 11,5dBi | Black | 20 pcs |
| LP345F 5G | 216257 | E5-E12 + DAB E21-E48 | 174-240 MHz 470-694 MHz | 9,5dBi 11,5dBi | White | 20 pcs |

TAU 5G SERIES

| Product | Code | Channels | Bands | Gain | Packaging |
|--------------------|--------|----------|-------------|---------|---------------------------------------|
| TAU11/45 5G | 213108 | E21-E48 | 470-694 MHz | 14.5dBi | Single: plastic bag, multiple: 10 pcs |
| TAU15/45 5G | 213107 | E21-E48 | 470-694 MHz | 15dBi | Single: plastic bag, multiple: 8 pcs |



HEADQUARTER

Fracarro Radioindustrie SRL

Fracarro (UK) Ltd

