

DS-1273ZJ-135

Wall Mount



Feature

- Aluminum alloy with surface spray treatment
- The cable hole design facilitates the cable routing
- The cap design facilitates the installation

Dimension

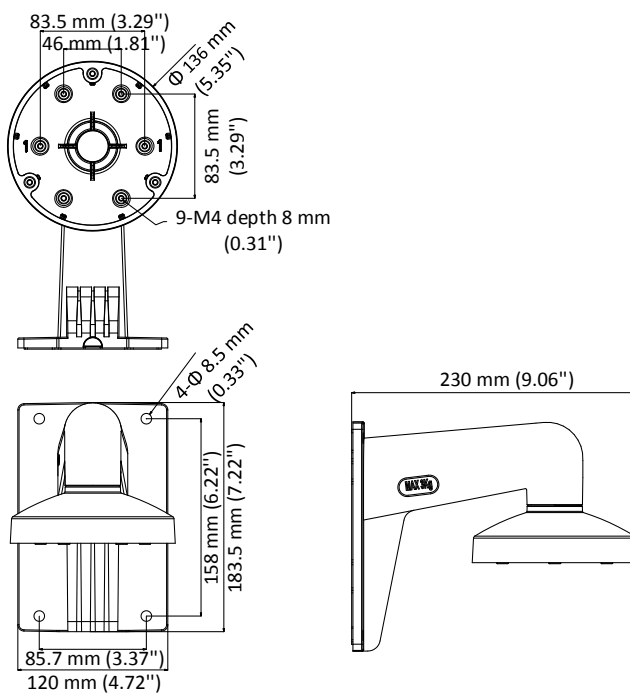

Available Model

DS-1273ZJ-135

Parameter

Model	DS-1273ZJ-135
Parameters	Wall Mount
Appearance	Hikvision White
Material	Aluminum Alloy
Dimension	Ø 136 mm × 183.5 mm × 230 mm (5.35" × 7.22" × 9.06")
Weight	755 g (1.66 lb.)

Note

- The mount should be installed on the flat wall.
- The waterproof rubber is necessary for the outdoor application.
- The pole must be capable of supporting at least 3 times as much as the total weight of the camera, and the mount.
- The mount's maximum load capacity is 3 kg (6.6 lb.).