

FIBRE OPTIC SOLUTIONS

Distribution

Active devices

Accessories & meters

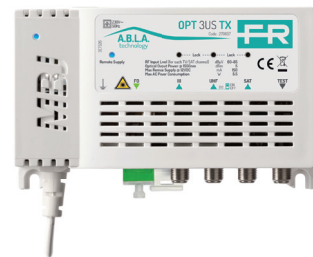
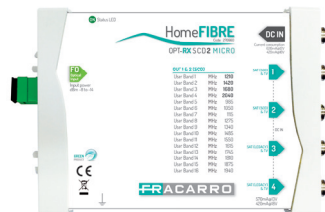
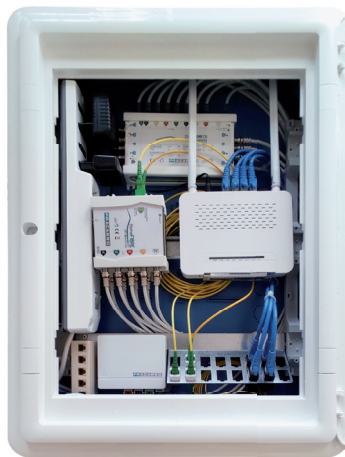

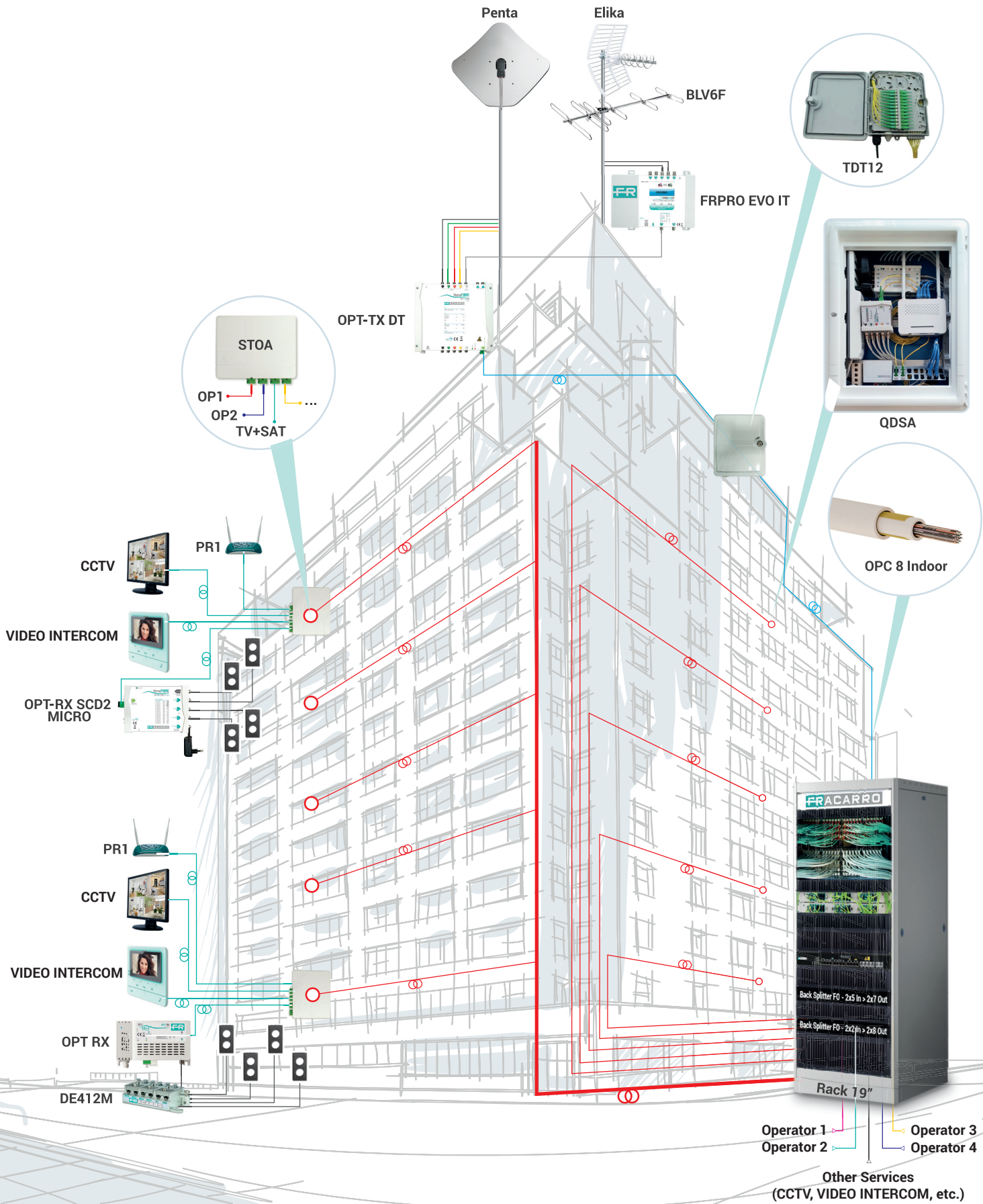

SOLUTIONS FOR FIBER OPTIC DISTRIBUTION

CSOE = BUILDING OPTICAL SERVICES CABINET

Located in a suitable technical room, **the CSOE is the access point where all the main services available in the building converge (TV, SAT, telephone provider, etc.)**. From this point, the optical fibres that connect all the apartments of the building depart. The services of each operator and the TV SAT signals arrive at the MDU (Multi-Dwelling Unit) to be sorted to the various apartments through the CSOE.

- Compatible solution for **installation on a 19-inch rack** (item 287418 CSOE 2U)
- Solution prepared for splicing fibre cables in the field or for pre-wired STOA's
- **PLC optical splitters can be used to carry out the MDU.**



CSOE 2U

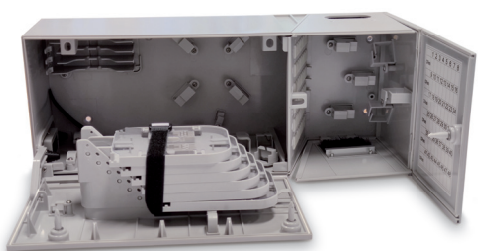

CSOE_P

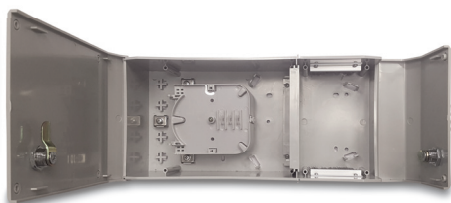

CSOE_MINI_P

CODE	ITEM	DESCRIPTION
287418	CSOE 2U	Metal box for FTTH cabling -suitable for 19" rack (size 454x152x180mm)
287444	PMI 24	PMI 24 Metal box for distribution from the CSOE to residential units with 24 pigtails and 2 splice trays (size 450x150x150mm)
287445	PMI 48	PMI 48 Metal box for distribution from the CSOE to residential units with 48 pigtails and 4 splice trays (size 454x150x150mm)
287567	CSOE_P	Building optical services cabinet in plastic material (IP54) for FTTH multiservice systems (CEI306-2) complete with 6 splicing organizers and accessories (size 450x180x150mm)
287566	CSOE_MINI_P	Miniaturized building optical services cabinet in plastic material (IP54) for FTTH multiservice systems complete with 4 splicing organizers and accessories (size 332x155x105mm)

TV/SAT services at input

Towards the STOA in the dwellings

Operator 1 services at input

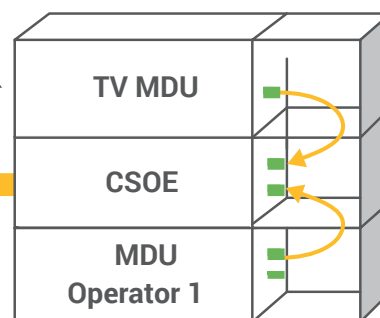

TDT Optical box

The **TDT** is essential to **organize the optical connections of the signals available in the attic** (TV, SAT, provider). The container is made of IP66 plastic material for wall and mast installation, complete with 20-position splice tray and 12 SC/APC adapters.

- Indoor and outdoor installation
- IP66 protection for the TDT12
- Complete with splice tray and optical adapters



TDT 12

CODE	ITEM	DESCRIPTION
287419	TDT 12	Optical box with IP66 protection in plastic material complete with splice tray and SC/APC adapters, lock with key (size 235x205x60mm)
287441	TDT 32	Optical box for indoor use complete with splice tray (up to 32 splices)(size 205x136x55mm)
287442	JTDT 32	Cable protection cover for TDT32.



JTDT 32

TDT 32

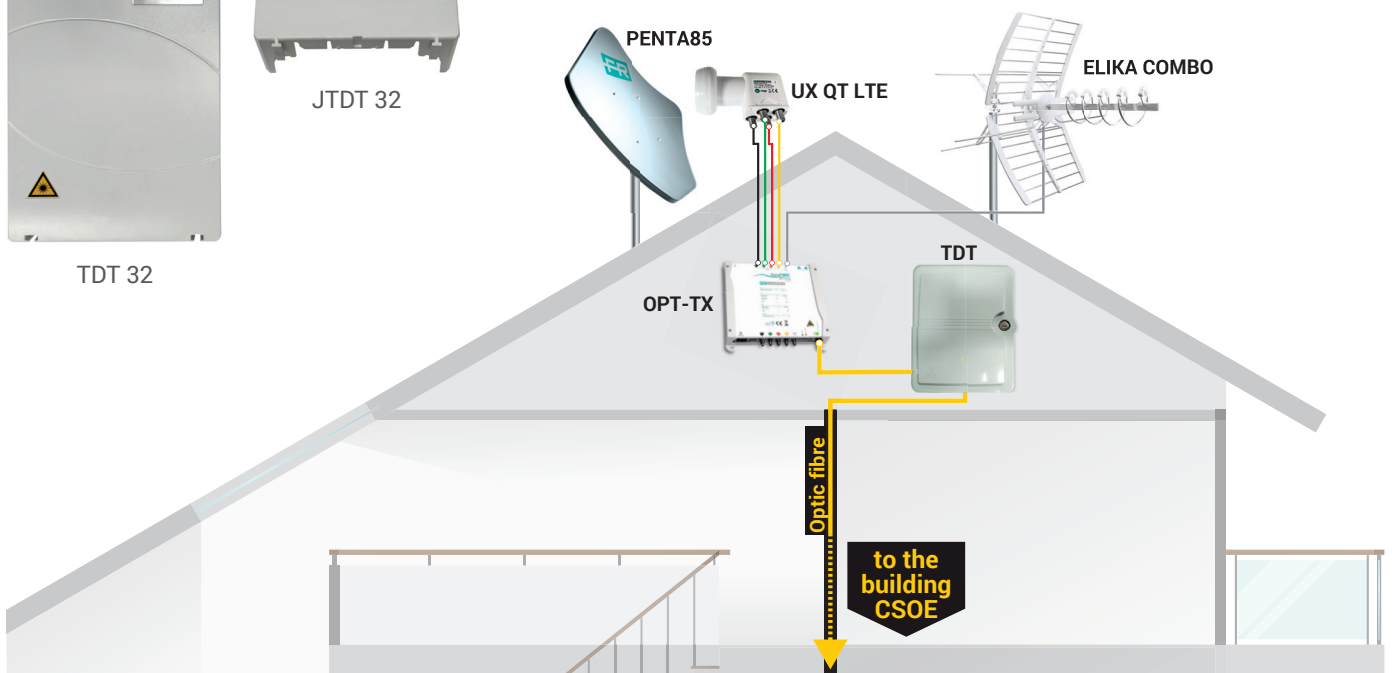

STOA = APARTMENT TERMINATION BOX

It is the **terminal point** provided for by the multiservice system and **must be installed very close to the real estate units, usually within the QDSA**. The STOA is available both pre-wired (with different cable lengths) and as a solution to be wired. Each STOA is equipped with 4 SC/APC optical connectors (2 for operator services and 2 for TV/SAT services).

- Fibre management standards **EN50411-3-4** and **EN50411-3-8**
- Pre-wired and to be wired solutions
- **Dustproof connectors** with Shooter

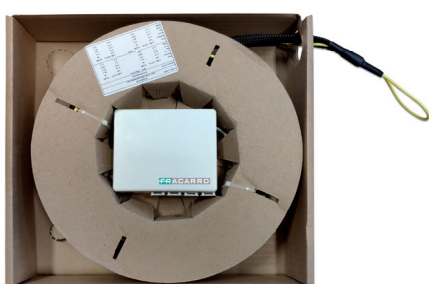

STOA 4 ..



STOA 4

**New
2021**

New STOA's prewired only on the STOA side with 30m of 4-fibre cable will be available from May 2021

CODE	ITEM	DESCRIPTION
287420	STOA 4	Apartment termination box with 4 SC/APC adapters with Shooter
287511	STOA 4 10m	STOA with 4 SC/APC adapters with Shooter with 10m cable with 4 fibres, pre-connectorized on both sides.
287512	STOA 4 20m	STOA with 4 SC/APC adapters with Shooter with 20m cable with 4 fibres, pre-connectorized on both sides.
287513	STOA 4 30m	STOA with 4 SC/APC adapters with Shooter with 30m cable with 4 fibres, pre-connectorized on both sides.
287514	STOA 4 40m	STOA with 4 SC/APC adapters with Shooter with 40m cable with 4 fibres, pre-connectorized on both sides.
287515	STOA 4 50m	STOA with 4 SC/APC adapters with Shooter with 50m cable with 4 fibres, pre-connectorized on both sides.
287516	STOA 4 100m	STOA with 4 SC/APC adapters with Shooter with 100m cable with 4 fibres pre-connectorized only on the STOA side.
287584	STOA 4 10m LITE	STOA 4 with 4 SC/APC adapters with Shooter with 10m cable with 4 fibres pre-connectorized only on the STOA side.
287585	STOA 4 20m LITE	STOA 4 with SC/APC adapters with Shooter with 20m cable with 4 fibres pre-connectorized only on the STOA side.
287586	STOA 4 30m LITE	STOA 4 with SC/APC adapters with Shooter. pre-connectorized only on the STOA side.
287587	STOA 4 40m LITE	STOA 4 with SC/APC adapters with Shooter with 40m cable with 4 fibres pre-connectorized only on the STOA side.
287588	STOA 4 50m LITE	STOA 4 with SC/APC adapters with Shooter with 50m cable with 4 fibres pre-connectorized only on the STOA side.

(* size of all STOA's: 100x29x80mm

QDSA (MULTIMEDIA ENCLOSURE)

It is the **optical termination panel of the apartment** where the fibre optic cables coming from the CSOE arrive. Within the QDSA, all services are organized and distributed to the apartment sockets (data, TV, SAT).

(New products are highlighted in green)

- Prepared **to house passive and active devices**
- In **plastic or metal** version
- Spaces suitable for the distribution of apartment signals

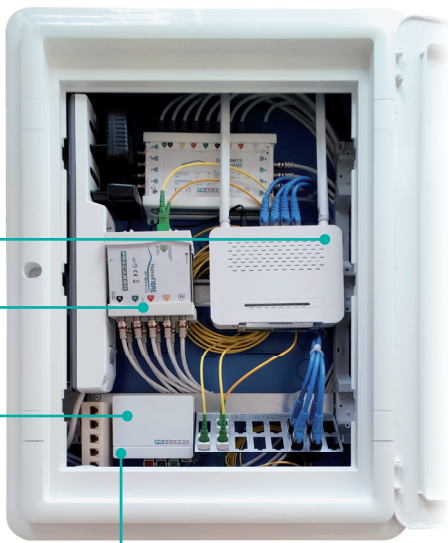

QDSA

STOA

Termination box for the optical fibre arriving from the CSOE

FIBRE OPTIC

Cable with 4 optical fibres coming from the CSOE

TV/SAT SERVICE

Fibre optic receivers

DATA SERVICE

WiFi modem/router with fibre optic input

CODE	ITEM	DESCRIPTION
287472	QDSA	Apartment box (54 modules) to be walled in, complete with 2 DIN bars with relative hooks for Router, active RJ45 patch-cord devices for data and SC/APC adapters for connections to the STOA (size 455x136x610mm excluding frame)
287517	QDSA MINI F	Miniaturized wall-mounted apartment box to house active devices. Complete with SC/APC adapters for connections to the STOA (size 390x305x110mm excluding frame)
287565	QDSA-F	Distribution (metallic) Panel of Apartment Signals for FTTH multiservice systems, complete with brackets and accessories (size 577x407x100mm excluding frame)
287569	QDSA-36-P	Miniaturized Distribution Panel For Apartment Signals in plastic material (36 modules), IP40, empty, for FTTH multiservice systems (external size 430x410x80mm)
287570	QDSA-54-P	Standard Distribution Panel for Apartment Signals in plastic material (54 modules), IP40, empty, for FTTH multiservice systems (external size 430x618x80mm)



QDSA-36-P



QDSA F



QDSA MINI F

Pigtails and optical interconnect adapters

SC/APC, SC/PC, FC/APC, FC/PC and Mini adapters for optical connections of the equipment.

- Different types of connection
- **Different lengths**
- 9/125 G657 A2 single mode adapters.

Fibre cables for corrugated pipes of contained dimensions, where the replacement of the coaxial cable is necessary to reduce the installation space when the number of services increases.

- LSZH sheath for indoor use and in PE for outdoor use
- 9/125 G657A2 single mode fibre

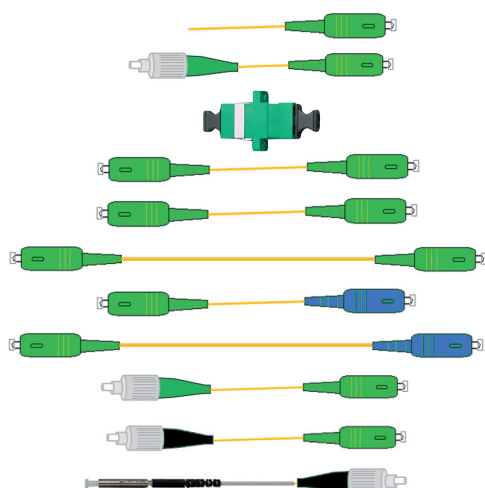

CODE	ITEM	DESCRIPTION
287426	PIG TAIL	Pig Tail 900µm F.O. 9/125 1m long SC/APC
280011	FC-SC/APC	FC/APC -SC/APC 0.5m long (including adapter)
289349	BFO-SC-APC	SC/APC-SC/APC optical adapter
287522	BR1-AA	SC/APC -SC/APC 1m long
289360	BR2-AA	SC/APC -SC/APC 2m long
289362	BR4-AA	SC/APC -SC/APC 4m long
289359	BR2-PA	SC/APC -SC/PC 2m long
289361	BR4-PA	SC/APC -SC/PC 4m long
287427	BR2SCAPC-FCAPC	SC/APC -FC/APC 2m long
287521	BR2FC/PC-SC/AP	SC/APC -FC/PC 2m long
287428	BR2FCAPC-MINI	FC/APC -Mini 2m long

Multi-fibre “Loose Tube” fibre optic cables for indoor use

Extra flexible multi-fibre cables for indoor use and armored cables for outdoor use

- LSZH sheath for indoor use
- Loose Tube Cable
- 9/125 ITU-T G657 single mode fibre

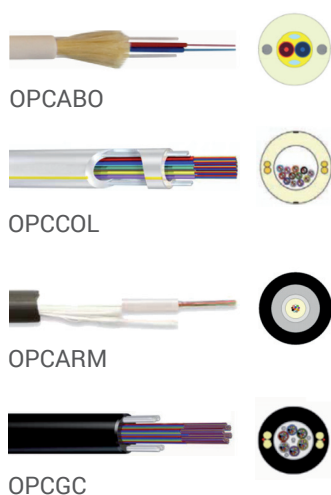

CODE	ITEM	DESCRIPTION
287446	OPCABO2	indoor use, 2 fibres, G657A2, 250m reel
287447	OPCABO4	indoor use, 4 fibres, G657A2, 250m reel
287425	OPC 8 Indoor	Indoor indoor use, 8 fibres, G657A2, 500m reel
287452	OPCCOL12	indoor use, 12 fibres, G657A2 (on request)
287344	OPC4ARM	4 fibres, outdoor use, glass yarn armor (500m reel)
287346	OPC8ARM	8 fibres, outdoor use, glass yarn armor (500m reel)
287448	OPCGC12	12 fibres, outdoor use, glass yarn armor (on request)
287449	OPCGC24	24 fibres, outdoor use, glass yarn armor (on request)

Compact and MINI PLC (Planar Lightwave Circuit) optical splitters and miniaturized splitters with MINI connector

Compact PLC (Planar Lightwave Circuit) optical splitters. Characterized by high quality and high performance with low insertion loss, PLCs are splitters suitable for building ROEs from 2 to 64 ways. The splitters of the VOV family have been designed to be housed in very small spaces such as flush-mounting boxes or shafts. *(New products are highlighted in green)*

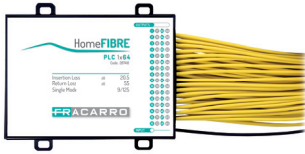

PLC1x64



PLC 1X4 MINI

CODE	ITEM	DESCRIPTION
287573	PLC 1x2	2 ways with SC/APC connectors, adapters 1m long (loss 4dB)
287455	PLC 1x4	4 ways with SC/APC connectors, adapters 1m long (loss 7.6dB)
287407	PLC 1x8	8 ways with SC/APC connectors, adapters 1m long (loss 10.9dB)
287574	PLC 1x12	12 ways with SC/APC connectors, adapters 1m long (loss 13.1dB)
287408	PLC 1x16	16 ways with SC/APC connectors, adapters 1m long (loss 14dB)
287575	PLC 1x24	24 ways with SC/APC connectors, adapters 1m long (loss 16.3dB)
287409	PLC 1x32	32 ways with SC/APC connectors, adapters 1m long (loss 17.2dB)
287410	PLC 1x64	64 ways with SC/APC connectors, adapters 1m long (loss 20.5dB)
287576	PLC 1x2 MINI	Mini 2 ways with SC/APC connectors, adapters 1m long (loss 4dB)
287577	PLC 1x4 MINI	Mini 4 ways with SC/APC connectors, adapters 1m long (loss 7.6dB)
287578	PLC 1x8 MINI	Mini 8 ways with SC/APC connectors, adapters 1m long (loss 10.9dB)
287579	PLC 1x12 MINI	Mini 12 ways with SC/APC connectors, adapters 1m long (loss 13.1dB)
287580	PLC 1x16 MINI	Mini 16 ways with SC/APC connectors, adapters 1m long (loss 14dB)
287581	PLC 1x24 MINI	Mini 24 ways with SC/APC connectors, adapters 1m long (loss 16.3dB)
287582	PLC 1x32 MINI	Mini 32 ways with SC/APC connectors, adapters 1m long (loss 17.2dB)
287583	PLC 1x64 MINI	Mini 64 ways with SC/APC connectors, adapters 1m long (loss 20.5dB)

FIBRE OPTIC ACTIVE DEVICES

Home Fibre TV SAT Optical Transmitters

Made for the distribution of terrestrial TV, satellite and radio signals on residential buildings, including large ones, **the transmitters of the Home Fibre series** allow the distribution of up to 4 satellites on a single optical fibre with CWDM (Coarse Wavelength Division Multiplexing) technology. Solution that allows to transmit the entire TV band, including radio signals, and an entire orbital position on a single fibre.

- TX with different wavelengths available (1310nm, 1510nm, 1530nm, 1550nm, 1570nm)
- High optical output level (up to **+7dBm**).
- **Independent automatic gain control circuits** for each single satellite polarity
- Ability to manage up to **4 different satellites** and mix them in a single optical fiber through the use of external passive CWDM diplexers
- Full band DVB-T+FM+DAB+Full satellite distribution.



OPT-TX DT



OPT-TX...

CODE	ITEM	DESCRIPTION
270694	OPT-TX DT	7dBm with FP laser SAT+TV+FM Wavelength 1310nm
270667	OPT-TX 1510	7dBm with DFB laser SAT+TV+FM Wavelength 1510nm
270668	OPT-TX 1530	7dBm with DFB laser SAT+TV+FM Wavelength 1530nm
270669	OPT-TX 1550	7dBm with DFB laser SAT+TV+FM Wavelength 1550nm
270670	OPT-TX 1570	7dBm with DFB laser SAT+TV+FM Wavelength 1570nm

OPT-TX size: 230x230x50mm

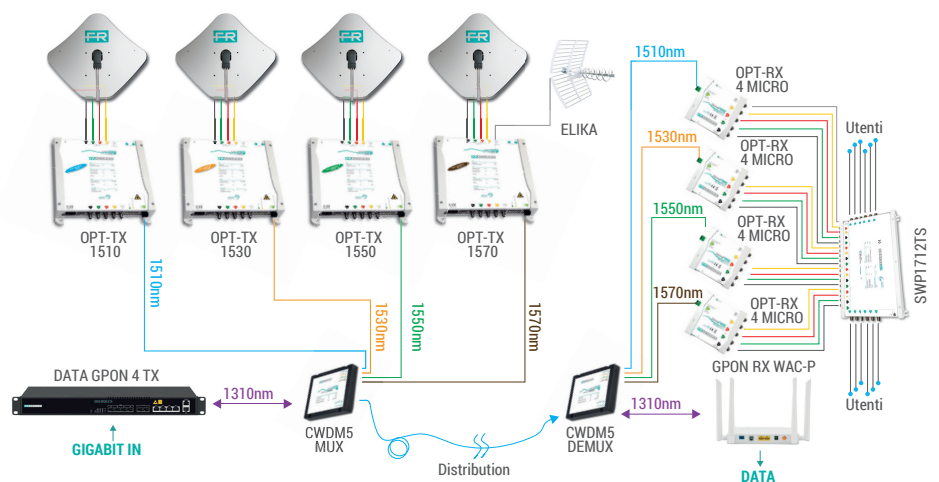

Home Fibre TV SAT Optical Receivers

The **optical receivers** of the **Home Fibre** family are designed to meet the distribution needs of digital terrestrial TV and satellite signals with **QUAD** (4 universal outputs), **Quattro** (4 HVHV + TV outputs) and **SCR / dCSS solutions for Sky Q solutions**; the **optical receiver** of the **OPT-MBJ** family is also available with output for Digital Terrestrial signals.

- New range of **MICRO optical receivers** with reduced mechanics for easy insertion in the QDSA (concentrated or distributed);
- **Multicolored LED** for diagnostics and receiver status
- Perfect **compatibility** with **dCSS installations** (SKY Q)
- Full band DVB-T+FM+DAB+full Satellite solution



OPT-RX SCD MICRO



OPT-RX QD MICRO



OPT-RX 4 MICRO



PSU1506

CODE	ITEM	DESCRIPTION
270660	OPT-RX SCD MICRO	Single cable 2 (SCD2) optical receiver equipped with 4 outputs, 2xdCSS with 16 user bands+TV for each output, and 2 Legacy+TV outputs, SC/APC optical connector (size 160x100x36mm)
270661	OPT-RX QD MICRO	MICRO Satellite TV Optical receiver with 4 legacy SAT+TV+FM universal outputs, optical SC/APC connector (size 120x100x36mm)
270662	OPT-RX 4 MICRO	TV SAT QUATTRO Optical receiver with HL, VL, HH, VH, TV+FM outputs, optical SC/APC connector (size 120x100x36mm)
270655	OPT-RX	Self-powered Optical receiver of the OPT-MBJ family equipped with TV+SAT, A.G.C. and optical SC/APC connector (size 135x82x39mm)
287155	PSU1506	Switching power supply 600mA@15V (recommended for OPT-RX SCD MICRO)

OPT-MBJ series Optical transmitters and receivers

The **OPT MBJ Series “Plug & Play”** optical transmitters and receivers are able to mix the bands 3, UHF and SAT (IF-IF), distributing them in optical fibre through the multiservice infrastructure in **medium-sized structures**.

- **“Plug&Play”**: no adjustment
- **A.B.L.A technology**: in the transmitters the optical signal is kept constant at the output if the TV and SAT RF input levels are between 60dBµV and 85dBµV;
- The **OPT RX** receiver is equipped with **Automatic Gain Control** that keeps the RF output constant if the received optical signal is within its working range.
- Plastic frame in **fireproof ABS material** (Class V0)
- **Very low power consumption**;
- **A.B.L.A circuits** operating LED for an immediate diagnosis of the RF input levels in the TX;
- **Diagnostic LEDs** of the correct **optical signal** and the **presence of the RF level** in the OPT RX receiver;
- Wall or DIN rail mounting.

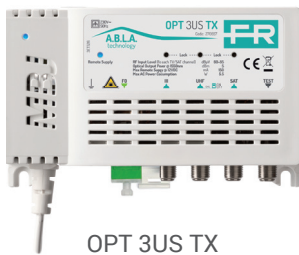

OPT 3US TX

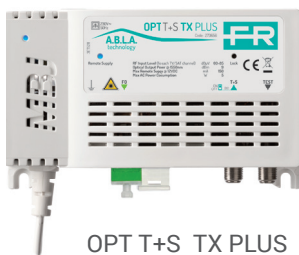

OPT T+S TX PLUS

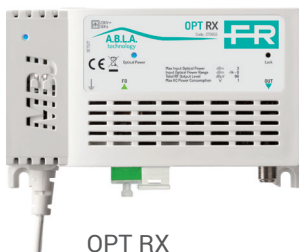

OPT RX

CODE	ITEM	DESCRIPTION
270657	OPT 3US TX	Plug & Play optical transmitter with 3 separate independent inputs: VHF, UHF and SAT (IF-IF). Optical SC/APC output and coaxial test output. Output Power 5dBm@1550nm; splitting up to 32 times when paired with the new OPT RX receiver. Remote feeding that can be enabled on the UHF input.
270656	OPT T+S TX PLUS	Plug & Play optical transmitter with 1 mixed TV/SAT (IF-IF) input. SC/APC Optical output and coaxial test output. Very high output power 9dBm@1550nm; splitting up to 64 times when paired with the new OPT RX receiver. Remote feeding that can be enabled on the TV+SAT input.
270655	OPT RX	Plug & Play optical receiver with SC/APC optical input (extended range from 0dBm to -14dBm). Automatic gain control for stabilization of TV / SAT signals. It can also be used as a replacement for the OPT RX TV (code 270696) . Signaling LED for the presence of optical and RF signal.

OPT-MBJ size: 135x82x39mm

IF-IF satellite head-ends

New compact IF-IF head-ends with **SCD2 (dcSS)** technology with 4 satellite inputs to convert up to 32 DVB-S/S2 transponders (selectable bandwidth 20-60MHz).

- **Two versions available:** standard SCD2-32IF and with high output level SCD2-32IF SSA
- **Automatic Gain Control**
- Maximum flexibility in output
- **Configurable from PC**



SCD2-32IF



SCD2-32IF SSA

CODE	ITEM	DESCRIPTION
271130	SCD2-32IF	Head-end with 4 satellite inputs and 2 taps with 86dB μ V output level for each transponder. Allows you to serve sockets up to 90 meters from the head-end. 8dB satellite slope adjustment.
271138	SCD2-32IF SSA	Head-end with 4 satellite inputs, 1 passive SSA TV input and 1 mixed tap. Total satellite output level 128dB μ V. Allows you to serve sockets up to 150 meters from the head-end. Satellite gain adjustment 20dB, satellite slope adjustment 23dB.

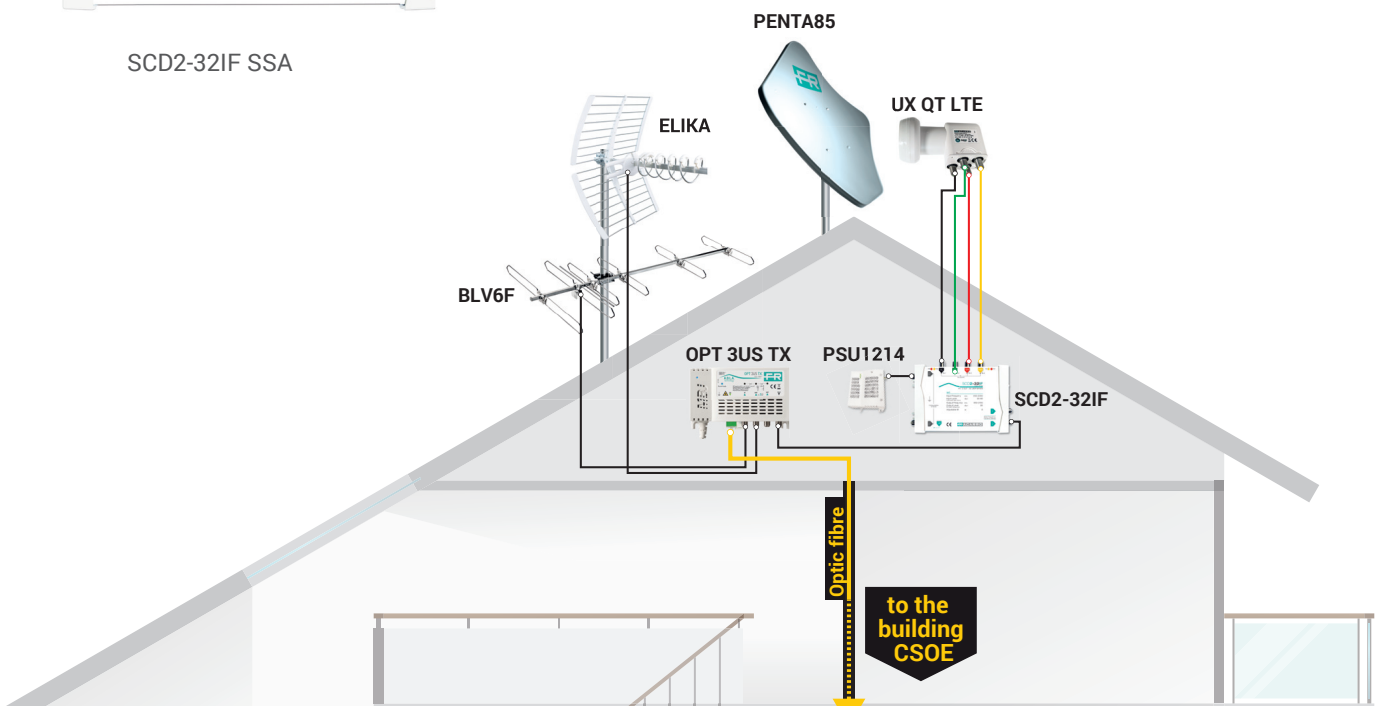

DATA distribution over fibre optic (GPON)

The **passive optical network** in Ethernet or Gigabit Ethernet (**E/GPON**) is a technology and a telecommunications system, also used by telecom providers, which **allows broadband to be brought to end users** via the passive fibre optic network. This type of **point-to-point solution is ideal for bringing connectivity to business and hospitality contexts** such as hotels, campsites, service sectors, etc. and allows to provide DATA connectivity at the end points and reach a very high bandwidth capacity (up to 2.5Gbit/s in download and up to 1.25Gbit/s in upload)



DATA GPON 4TX



DATA GPON 8TX



GPON RX W-TV P



GPON RX WAC-P



GPON RX LITE TV



GPON RX PASS TV

CODE	ITEM	DESCRIPTION
287558	DATA GPON 4 TX	OLT GPON. 4xPON. Uplink: 4xGE + 2xSFP 10GE. Double slot for power supply. Management via SNMP, WEB, CLI, Telnet. Size: 442x200x44mm.
287559	DATA GPON 8 TX	OLT GPON. 8xPON. Uplink: 8xGE + 6xSFP GE + 2xSFP 10GE. Double slot for power supply. Management via SNMP, WEB, CLI, Telnet. Size: 442x200x44mm.
287560	DATA SFP C++	SFP Module Class C++ Size: 64x13,4x13,6mm.
287555	DATA SFP GE	SFP module for uplink Size: 64x13,4x13,6mm.
287562	GPON RX W-TV-P	OONT GPON. GPON receiver with 2 RJ45 ports (1xGE, 1xFE), 1 FXS phone port, 1 CATV port with IEEE802.11n WiFi connectivity. Size: 185x33x122mm.
287561	GPON RX WAC-P	ONT GPON. GPON receiver with 2 RJ45 ports (2xGE), 1 FXS phone port, 1 CATV port with IEEE802.11ac WiFi connectivity. Size: 178x30x120mm.
287557	GPON RX LITE TV	GPON receiver with 1 RJ45 port (1xGE) and 1 CATV port (47-1000MHz). Size: 82x82x25mm.
287556	GPON RX PASS TV	Passive GPON receiver with integrated WDM and a CATV port (47-1000MHz). Size: 75x55x28mm.

CWDM Optical Diplexers

Using **CWDM products** it is possible to mix numerous services within a single fibre, using different wavelengths.

- Solutions with 2 or 5 wavelengths
- 1m optical adapters, SC/APC both on input and on outputs



WDM2



OPTATT...

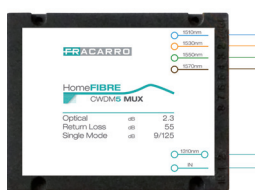

CWDM5

CODE	ITEM	DESCRIPTION
287343	WDM2	Optical multiplexer with 2 wavelengths 1310-1490 / 1500-1600, 1m SC/APC connectors
287342	CWDM5	Optical multiplexer with 2 wavelengths 1310-1490 / 1510 / 1530 / 1550 / 1570, 1m SC/APC connectors.
287237	OPTATT14dB	14dB optical attenuator, SC/APC connectors
287238	OPTATT7dB	7dB optical attenuator, SC/APC connectors
287239	OPTATT3dB	3dB optical attenuator, SC/APC connectors

EDFA optical amplifier

High performance EDFA (Erbium Doped Fibre Amplifier) optical amplifiers, made for CATV type distributions for long transmission distances on HFC and FTTH networks.

- APC Automatic Power Control (for CATV distributions)
- AGC Automatic Gain Control
- ACC Automatic Current Control



EDFA 4 WDM



EDFA 8 WDM

CODE	ITEM	DESCRIPTION
287554	EDFA 4 WDM	EDFA optical amplifier with integrated WDM diplexer. 5 x input/output SC/APC 1550nm. 4 x SC/PC for data mixing. Output power 29dBm (4x22dBm). Management via keyboard and front display, WEB interface or SNMP. Size: 370x486x44mm.
287553	EDFA 8 WDM	EDFA optical amplifier with integrated WDM diplexer. 9 x input/output SC/APC 1550nm. 8 x SC/PC for data mixing. Output power 31dBm (8x21dBm). Management via keyboard and front display, WEB interface or SNMP. SC connectors with flap. 2U Rack Mount. Size: 422x486x88mm.

Fusion Splicers

FST-83A Core alignment portable fusion splicer.

Professional fusion splicer with 4 motors, with 3-axis core alignment, complete with cutter, fibre stripper, isopropyl alcohol, wipes and rigid carrying case.

- Core alignment fusion splicer with 4 motors
- Complete with accessories.



FST-83A

FST-83A	Fusion Splicer
Code	287535
Features	
Splicing mode	Automatic, manual
Fibre types	SM / MM / DS / NZDS
Splicing programs	SM, MM, OM1
Typical splice loss	0.01dB - 0.05dB
Typical splicing time	6-10 Sec.
Monitor	4.3" high resolution LCD, touch screen
Zoom	500x
Working temperature	-10° C ~ +50° C
Size, weight	140×165×148 mm, (1.9KG)
Power supply	AC 100~240V – 5200mAh lithium battery incl.

Fibre optic cleaning tools

Cleaning tools consisting of a connector kit, wipes for cleaning optical fibres and adapters, isopropyl alcohol.



Cleaning Kit

CLEANING KIT	Kit per la pulizia dei connettori
Code	287536
Features	
Fibre and connector types	SM, 9/125um, SC/APC, SC/PC
Contains	wipes, cleaning sticks, flashlight, cleaning spray

Optical multimeters

OPT METER Optical multimeter with testing on RJ45 cables

Portable multifunction optical multimeter with Visual Fault Locator and testing functionality for RJ45 cables.



OPTmet+RJ45test

OPTmet+RJ45test	Optical multimeter + VFL and RJ45 test
Code	287568
Features	
Wavelengths	850-1300-1310-1490-1550-1625nm
Power level measured	from -50 up to + 26dBm
Accuracy	0,2dB
Connector	2,5mm universal
Port	mini USB
Battery	lithium ions (included)
Battery Life	> 160 h
Working temperature	-10°C ~ +50°C
Size, weight	59x98x27 mm, 100g

OPT METER Optical multimeter

Optical multimeter for different wavelengths, with integrated source for checking multiservice systems and fibre optic distributions.



OPT METER

OPT METER	Optical multimeter
Code	287537
Features	
Wavelengths	850-1300-1310-1490-1550-1625nm
Power level measured	from -70 up to +10dBm
Accuracy	0,2dB
Connector	SC/PC
Port	mini USB
Battery	AA x 3 (not included)
Battery life	> 160 h
Size, weight	-10°C ~ +50°C
Size, weight	168x95x38 mm, 330g

Field meters

Combined Field Meters Automatic Satellite DVB-S/S2, Digital Terrestrial DVB-T/T2 and CATV DVB-C with Touch Screen. Complete with DiSEqC, with SCR and DCSS (SCD2) protocols.

HEVC Main 10 video compression, MPEG 2-4 with Full HD or SD image quality.

Real time spectrum analyzer and FO extension (FR 5 HEVC PRO).



FR 5 HEVC



FR 5 HEVC PRO

CODE	ITEM	DESCRIPTION
287572	FR 5 HEVC	Combined field meter DVB-S/S2 automatic satellite, DVB-T/T2 digital terrestrial and CATV DVB-C with Touch Screen. Complete with DiSEqC, with SCR and DCSS (SCD2) protocols. HEVC Main 10 video compression, MPEG 2-4 with Full HD or SD image quality. With real time spectrum analyzer.
287571	FR 5 HEVC PRO	Combined field meter DVB-S/S2 automatic satellite, DVB-T/T2 digital terrestrial and CATV DVB-C with Touch Screen. Complete with DiSEqC, with SCR and DCSS (SCD2) protocols. HEVC Main 10 video compression, MPEG 2-4 with Full HD or SD image quality. With real time spectrum analyzer and FO extension .

Accessories

Rack and wall accessories

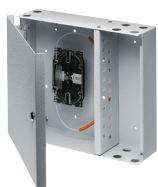

OPB181



OPB81



OPB24IR



OP012P

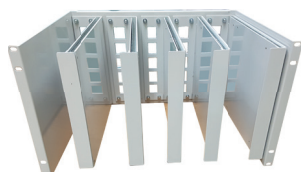

6U SLIDE PANEL

CODE	ITEM	DESCRIPTION
289403	OPB181	Metal wall box to protect eventual splices, up to 18 SC/APC connectors.
289405	OPB81	Metal wall box to protect eventual splices, up to 8 SC/APC connectors.
289404	OPB24IR	24-position tray for 19" rack
289402	OP012P	12-position stackable fibre organizer
287563	4U SLIDE PANEL	4U slide panel with con 7 removable sliding slots in painted metal
287564	6U SLIDE PANEL	6U slide panel with 5 removable sliding slots in painted metal

FRACARRO SERVICES

Creating a **Fibre Optic Fracarro plant** means having the most advanced technologies, with a **complete range of equipment** suitable for any type of plant. but not only. Fracarro also offers a series of important services to support installers:

PROJECT SUPPORT

Our professionals are available to design the system scheme suitable for your installation, complete with a list of materials.

REMOTE SUPPORT

From Monday to Friday, from 8:30am to 6:00pm (CET) for any technical request, information or programming of the system that you are developing.

Contacts: supportotecnico@fracarro.com | WhatsApp **+39.335.7762667**





Fracarro Radioindustrie SRL

via Cazzaro 3 31033 Castelfranco Veneto (TV) Italy

tel +39 0423 7361 - fax +39 0423 736220 - info@fracarro.com

www.fracarro.com

